



# RW4 *Plus*

Operating manual

D437145XA

VERS. 1.0

GB



© 2010 SILCA S.p.A - Vittorio Veneto

This manual has been drawn up by SILCA S.p.A.

All rights reserved. No part of this publication may be reproduced or used in any form or by any means photocopying, microfilm or other) without the written permission of SILCA S.p.A.

Edition: march 2010

Printed in Vittorio Veneto  
by SILCA S.p.A.  
via Podgora, 20 (Z.I.)  
31029 VITTORIO VENETO (TV) - Italy

**IMPORTANT NOTE:** *in compliance with current regulations relating to industrial property, we hereby state that the trade-marks or trade names mentioned in our documentation are the exclusive property of authorized manufacturers of locks and users. Said trade-marks or trade names are nominated only for the purposes of information so that any lock for which our keys are made can be rapidly identified.*

# INDEX

<b>1 MACHINE DESCRIPTION.....</b>	<b>6</b>
1.1 Main Features.....	6
1.2 Technical data .....	6
1.3 Working parts .....	7
1.4 Special features.....	8
1.5 Symbols used on the display .....	9
1.6 Electrical/electronic circuit .....	10
<b>2 TRANSPORT .....</b>	<b>11</b>
2.1 Packing.....	11
2.2 Transport .....	11
2.3 Unpacking .....	11
2.4 Machine handling .....	11
<b>3 ACCESSORIES PROVIDED .....</b>	<b>12</b>
<b>4 MACHINE INSTALLATION AND PREPARATION .....</b>	<b>12</b>
4.1 Preparation for use - preliminary operations.....	12
4.2 Checking for damage .....	12
4.3 Environmental conditions .....	12
4.4 Positioning.....	12
4.5 Software update .....	13
<b>5 REGULATION AND SETTING OF THE MACHINE .....</b>	<b>13</b>
<b>6 COM-CODE MODULE FOR CODING HOLDEN-COMMODORE KEYS (OPTIONAL).....</b>	<b>14</b>
6.1 Operative parts .....	14
6.2 Installation .....	14
6.3 Use .....	14
6.4 Software upgrade and use with PC .....	15
<b>7 USE OF THE MACHINE.....</b>	<b>16</b>
7.1 Turning on .....	16
7.2 Main menu.....	16
7.3 Key copying.....	16
7.3.1 Key reading.....	17
7.3.1.1 Calculation for Texas* Crypto transponder (60, 61, 62, 63, 64, 65, 67, 68, 69, 70, XX, 6F) .....	17
7.3.1.2 COPY Philips* Crypto transponders (42) .....	18
7.3.1.2.1 Key Regeneration 42 .....	18
7.3.1.3 COPY Philips* Crypto transponders (41) .....	18
7.3.1.4 COPY Philips* Crypto transponders (40) .....	18
7.3.1.5 Copy Philips* Crypto transponder (4W) .....	19
7.3.1.6 Copy Philips* Crypto transponder (45) .....	19
7.3.1.6.1 Regenerate Key 45.....	20
7.3.1.7 COPY Texas* Crypto2 (6F) transponder .....	20
7.3.1.8 COPY Philips* Crypto2 (46) transponder.....	21
7.4 Writing a key.....	25
7.5 Memorizing the code .....	26
7.6 Transponder identification .....	27
7.6.1 Reading code and type of transponder (ID) .....	28
7.6.2 Memorizing a code.....	28
7.6.3 Philips* Crypto Transponder (40, 41, 42, 44, 45, 4W, 4M, 4F) .....	28
7.6.3.1 Reading PINCODE on Philips* Crypto Transponder (45) .....	29

7.6.3.2	Copying the ID of Philips* Crypto Transponders (40 <sup>(1)</sup> , 44) ...	30
7.6.4	Texas Crypto Transponder (60, 61, 62, 63, 64, 65, 66, 67, 68, 69, 70) .....	31
7.6.4.1	Texas* Crypto2 (6F) Transponder .....	31
7.6.5	Electronic Key (Texas).....	33
7.6.6	Electronic Key (PHILIPS CR2).....	34
7.7	Copy by known code .....	35
7.7.1	Entering the code.....	35
7.7.2	Key writing .....	36
7.8	Code generation .....	37
7.9	Code archive .....	38
7.9.1	Viewing codes in the archive .....	38
7.9.2	Writing keys .....	39
7.10	Holden Commodore .....	40
7.10.1	Copy .....	40
7.10.2	Entering the code.....	41
7.11	Options .....	42
7.11.1	Language.....	42
7.11.2	Deleting the archive .....	42
7.11.3	Keyboard check .....	43
7.11.4	OPTIONS MENU: SNOOP .....	43
7.11.5	OPTIONS MENU: C-BOX-MB .....	43
7.12	Module.....	43
<b>8</b>	<b>WARNINGS.....</b>	<b>44</b>
8.1	Messages during key reading.....	44
8.2	Messages during key writing .....	46
8.3	Special events that could occur when copying a Philips* CR2 transponder:.....	47
<b>9</b>	<b>MAINTENANCE .....</b>	<b>49</b>
9.1	Trouble shooting.....	49
9.2	Checking the wiring .....	49
<b>10</b>	<b>WASTE DISPOSAL .....</b>	<b>50</b>
<b>11</b>	<b>ASSISTANCE.....</b>	<b>51</b>
11.1	How to request service .....	51

## GENERAL

This machine has been designed according to CE norms. The materials used in its manufacture are not dangerous and their use makes the machine comply to standards. The machine and all its parts are completely safe to use.

### Instructions manual

The instructions manual provided with the machine is essential to its proper use and to carry out the necessary maintenance.

We therefore recommend protecting the manual from damage in a safe sheltered place, easily to hand for quick consultation.

### Residual risks

There are no residual risks arising from use of the machine.

### Protection and safety precautions for the operator

The operations for which the machine has been designed are easily carried out at no risk to the operator.

The machine is designed with features which make it completely safe in all its parts.

### Safety

To operate in complete safety, before using the machine read and fully comprehend the concepts, instructions and regulations described in this user's manual.

- Periodically check the electric wiring. If the wires are frayed or worn, repair or replace immediately.
- Always work with dry hands, cleaning any grease or oil from them.
- Always disconnect the machine when it is not in use or when carrying out maintenance operations.
- Do not tug at the electric wiring and ensure that it does not come into contact with oil, sharp objects or heat. Never remove the earth wire from the plug.
- Ensure that the earth wire is always properly connected.
- Do not use the machine in dangerous environments (damp or wet).
- Always work in a well-illuminated location.
- Keep the working area clear and remove any tools from around the machine before turning it on.
- Any visitors, especially children, must stand at a safe distance from the machine and not be allowed to touch it or any of the wiring.
- Do not use the machine for purposes different from those described in this manual.
- Do not use the machine if the ON/OFF switch is not working properly.

### Power supply

The machine is supplied through a 15 Vdc universal power provider, supplied with the machine.

### Start-up

The machine is started up by means of the master switch (E).

### Machine identification

The machine is provided with an identification label which shows the serial number (fig. 1).

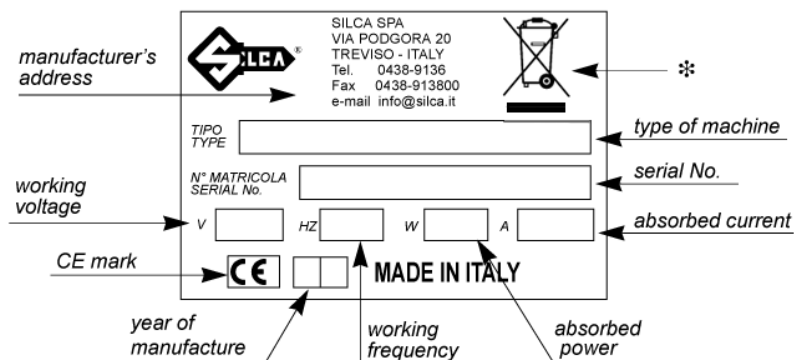

Fig. 1

(\*) see chap. 10 WASTE DISPOSAL, page 50.

# 1 MACHINE DESCRIPTION

The machine is used to easily duplicate many types of transponder keys for vehicles (125 KHz. ).

In particular, the machine is able to read and display the electronic code stored in the memory of Philips\*, Megamos\*, Temic\* and Texas\* transponders used on the keys, and re-write it on a blank transponder.

The machine works alone or connected to a personal computer. A functions menu is incorporated to meet all the needs arising during operation.

For a list of car makes and models whose keys can be copied, consult the articles published in the Silca catalogues and updates.

## 1.1 Main Features

### Operation modes

- copier/detector - transponder reader/writer
- stand-alone/with personal computer

### Special functions

- storage of transponder codes in the archive (max. 99)
- interface with HOLDEN - COMMODORE
- program in various languages
- machine test

### Software updating

The machine can be updated by connection to a personal computer via USB or RS232.

### Power supply

- directly from the mains through an external universal power provider and special cable.

## 1.2 Technical data

### POWER SUPPLY

- Universal AC/DC power supply in compliance with directive 2006/95/CE; carries UL mark.: 100/240 Vac - 50/60 Hz/15 Vdc - 3 A
- machine: 12-18Vdc - 10W

### ANTENNA FIELD FREQUENCIES

- 125 kHz

### DIMENSIONS

Width 245 mm  
Length 160 mm  
Depth 80 mm

### WEIGHT

Kg. 0,60

### 1.3 Working parts

The structure of the machine is extremely simple.

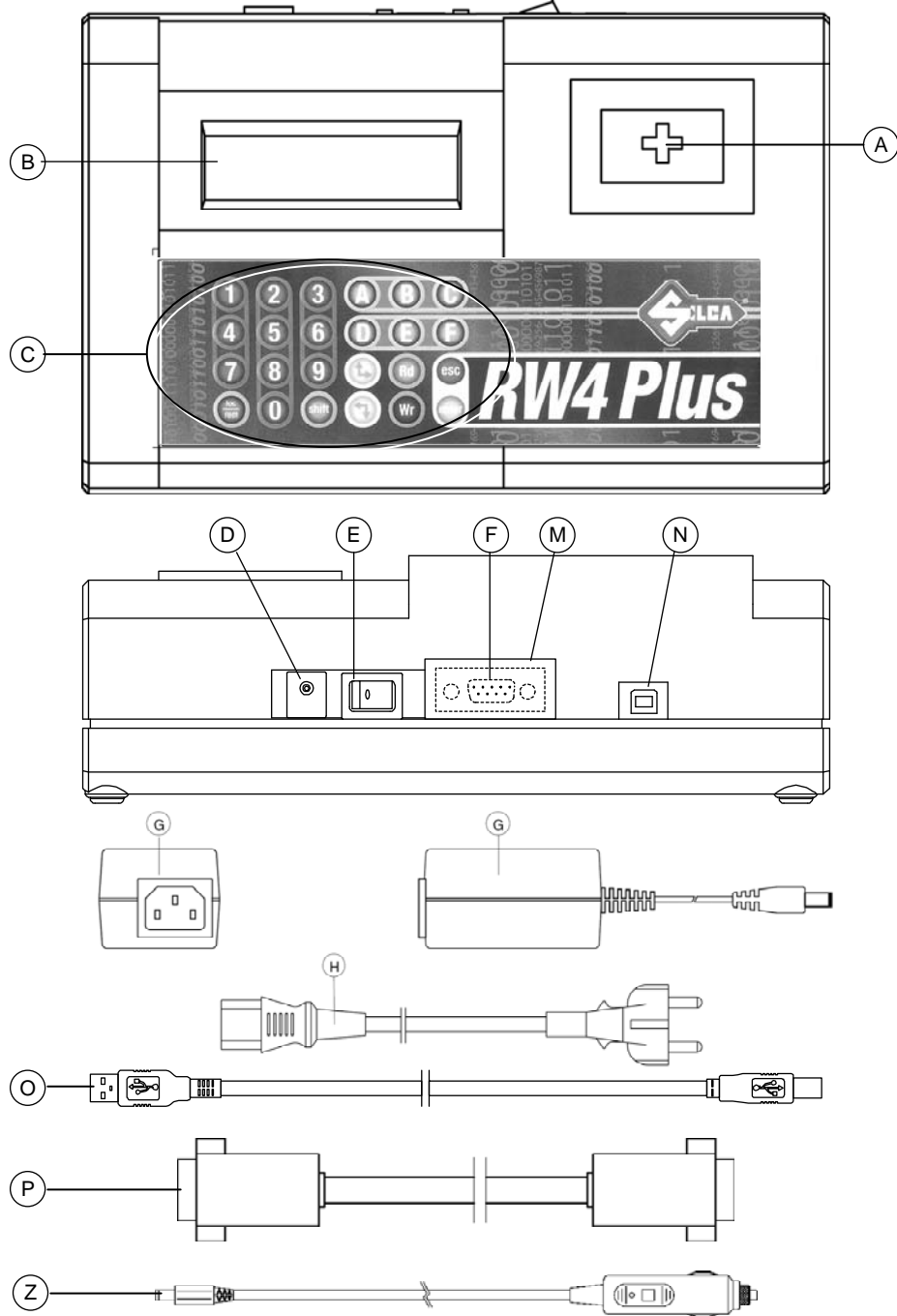

Fig. 2

- A - reading/writing antenna
- B - liquid crystal display for 20 + 20 characters (2 lines)
- C - 24-key keyboard
- D - 12-18 V d.c. power supply socket
- E - master switch (POWER ON)
- F - RS232 connector (9-pole)
- G - 15 V d.c. power provider
- H - power supply cable
- M - cover
- N - USB connector
- O - USB cable
- P - serial cable
- Z - cigarette lighter power supply cable

## 1.4 Special features













### KEYBOARD

The incorporated keyboard (Fig. 2, page 7) allows the user to interact with the machine rapidly and easily. At any given time only the keys relevant to the cycle in progress are enabled.



Fig. 3

The following keys are available:

-  Selection of local operation (STAND-ALONE)/remote (connected to a personal computer).
-  ...   ...  Entry of the electronic codes.
-   Up/down arrow keys to move the > up or down the characters on the display - selection. RH/LH operate with the shift key.
-  Enabling right/left-hand arrow - moving cursor to correct entry, if necessary.
-  Assent/confirmation for reading the data on the transponder.
-  Assent/confirmation for writing the data on a transponder.
-  Assent/confirmation function/selection.
-  Exit and return to main menu/sub-menus.

### LIQUID CRYSTAL DISPLAY

Alphanumeric display with 2 lines of 20 characters each, illuminated from behind.



## 1.5 Symbols used on the display

The wording in a rectangle represents what is shown on the display.  
The wording in a square at the side represents the key to press.

	I	N	S	E	R	T		O	R	I	G	I	N	A	L				
	K	E	Y														>	R	D



Words in a rectangle (more than two lines) represent a full menu with more than two items, which can be displayed by scrolling the > cursor down or up by means of the arrow keys.  
When an item has been selected from the menu, press the **ENTER** key.

>	C	O	P	Y															
	I	D	E	N	T	I	F	I	C	A	T	I	O	N					
	E	N	T	E	R	I	N	G				C	O	D	E				
	C	O	D	E		G	E	N	E	R	A	T	I	O	N				
	A	R	C	H	I	V	E												
	H	O	L	D	E	N		C	O	M	M	O	D	O	R	E			
	O	P	T	I	O	N	S												



If a warning appears on the display the machine cannot be used.

	W	R	I	T	I	N	G		E	R	R	O	R						



To quit this condition, press the **ESC** key.

## 1.6 Electrical/electronic circuit

### MAIN PARTS

1. **PRINTED CIRCUIT BOARD:** contains the microprocessor which runs the key reading/writing operations, the supply circuits, interface with the keyboard and display and the connectors between the antennas and personal computer.
2. **DISPLAY** liquid crystal, retro-illuminated, 2 lines of 20 characters.
3. Control **KEYBOARD** with 24 keys.
4. **USB RECEPTACLE**
5. **MASTER SWITCH**
6. **MAINS SUPPLY SOCKET** 15V/350 mA
7. **ANTENNAS** for reading/writing tuned to 125 kHz
8. **RS232 9 pole RECEPTACLE**
9. **CBOX-MB expansion board**

### OPERATIONAL ELECTRICAL BLOCK/CIRCUIT DIAGRAM

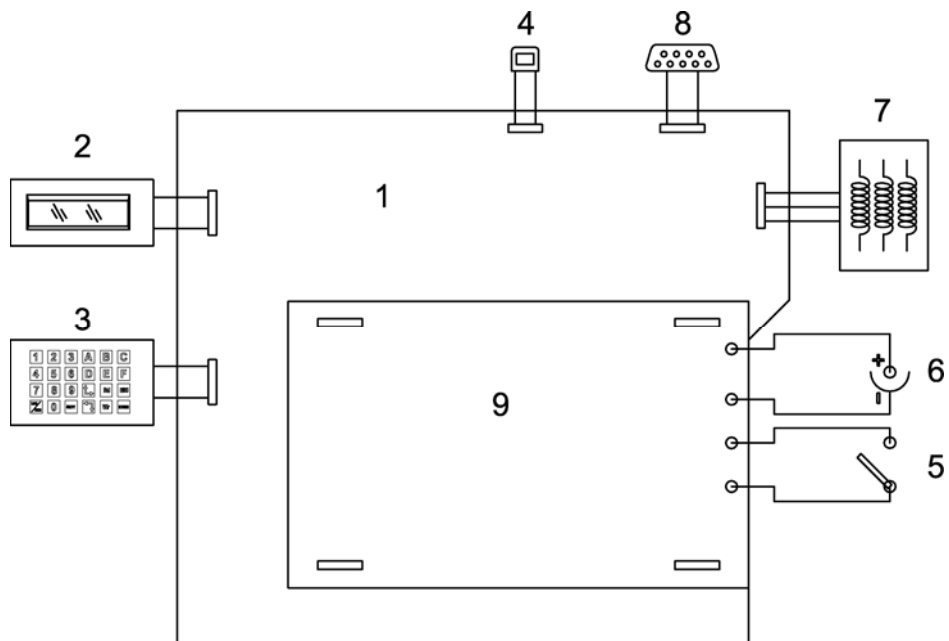

## 2 TRANSPORT

The machine is easily transported and is not dangerous to handle. The packed machine can be carried by one person.

### 2.1 Packing

The packing is designed to ensure safe transportation and protect the machine and all its parts.

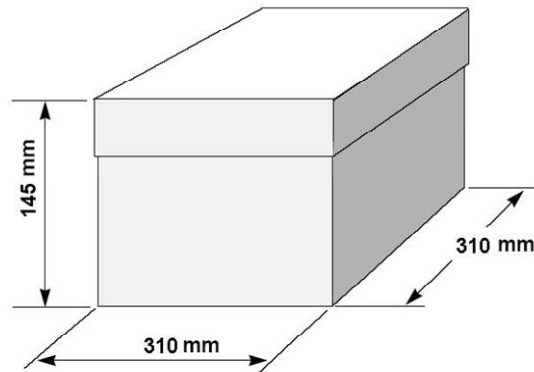

Fig. 4

### 2.2 Transport

It is advisable to use the packing every time the machine is transported, as this will avoid knocks causing damage.

### 2.3 Unpacking

To remove the machine from the packing box:

1. it is advisable to open the box without damaging it so that it may be used again (removals, dispatch to manufacturers for repairs or servicing);
2. check the contents of the box, which should comprise:
  - 1 machine
  - 1 universal power provider
  - 1 power cable
  - 1 serial cable
  - 1 USB cable
  - 1 set of documents, including: operating manual and spare parts list
  - 1 cd-rom
  - 1 cigarette lighter power supply cable

### 2.4 Machine handling

When the machine has been unpacked, place it directly on its workbench.

### 3 ACCESSORIES PROVIDED

The machine is supplied complete with:

- universal power provider;
- power cable;
- serial cable;
- USB cable;
- user's manual;
- cd-rom for stand-alone operation (to be used only if the program installed on the machine is lost)
- cigarette lighter power supply cable

### 4 MACHINE INSTALLATION AND PREPARATION

The machine can be installed by the purchaser and does not require any special skills; it is supplied ready for use. However, some checks and preparation for use need to be carried out by the operator.

#### 4.1 Preparation for use - preliminary operations

- turn on and select local operation (stand-alone);
- set up the language.

#### 4.2 Checking for damage

The machine is solid and compact and will not normally damage if transport, unpacking and installation have all been carried out according to the instructions in this manual.

However, it is always advisable to check that the machine has not suffered any damage.

Should faults be found which are not due to the above mentioned risks, contact the Silca After Sales Service.

#### 4.3 Environmental conditions

The machine working alone operates at an ambient temperature of -20 to +55°C

To ensure that the best use is made of the machine and relative keys with transponders, the operating temperature should be restricted. **Given the characteristics of the transponder on the key blanks THE KEYS MUST BE CODED IN AN ENVIRONMENT WITH A TEMPERATURE OF 20°C OR OVER.**

The ideal conditions for the machine are therefore:

- temperature between 20 and 40°C;
- relative humidity approx. 60%.

#### 4.4 Positioning

The machine does not require a special location; simply place on a horizontal surface of suitable size.

**ATTENTION:** the universal feeder provided with the machine and any electronic equipment should be placed at least 50 cm from the antenna to avoid their generating interference which could affect reading and/or writing of the transponder (see Fig. 5, page 13).

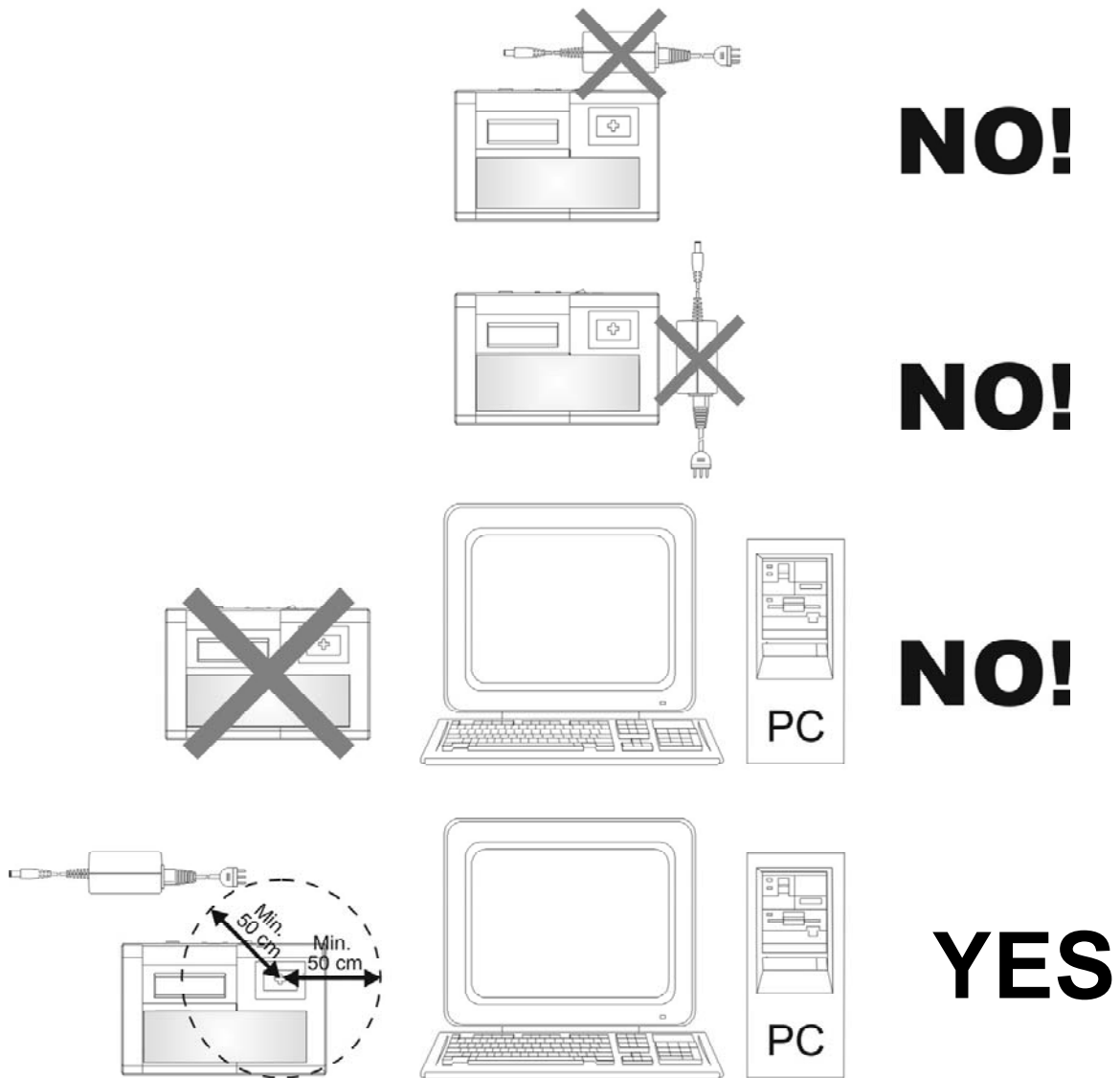

Fig. 5

#### 4.5 Software update

The machine's on-board software can be updated (for future expansion) through a personal computer, using USB port or RS232 serial port.

**ATTENTION:** the USB and RS232 inputs necessary for connection to a personal computer is placed on the back of the machine.

Use the USB or RS232 cable, and follow the instructions given on the update cd rom.

### 5 REGULATION AND SETTING OF THE MACHINE

The machine does not need any setting or regulation.

## 6 COM-CODE MODULE FOR CODING HOLDEN-COMMODORE KEYS (OPTIONAL)

Operational from version 1.0.

### 6.1 Operative parts

**Q** power cord (provided on the Com-Code module)  
**O** serial cable (provided on the Com-Code module)  
**G** universal input (provided on the machine)  
**P** computer connection serial cable (provided on the machine)  
**N** Com-Code  
**R** power lead from vehicle cigarette lighter (provided with Com-Code module) (Fig. 7)

**N1** module power input connector  
**N2** serial connector for PC connection  
**N3** machine power input connector  
**N4** serial connector for machine connection  
**N5** power supply warning light

### 6.2 Installation

No special skill is required to connect the module to the machine; use the two cords 'Q - power input' and 'O - serial' provided on the Com-Code module.

### 6.3 Use

The module does not interfere with machine connection to a PC.  
Both the machine and the module can be powered through the vehicle cigarette lighter.  
The two figures "Fig. 6" and "Fig. 7" show the various uses for the machine and module.

---

**N.B: whatever power supply configuration is chosen, the module is active only if the red light (N5) is on.**

---

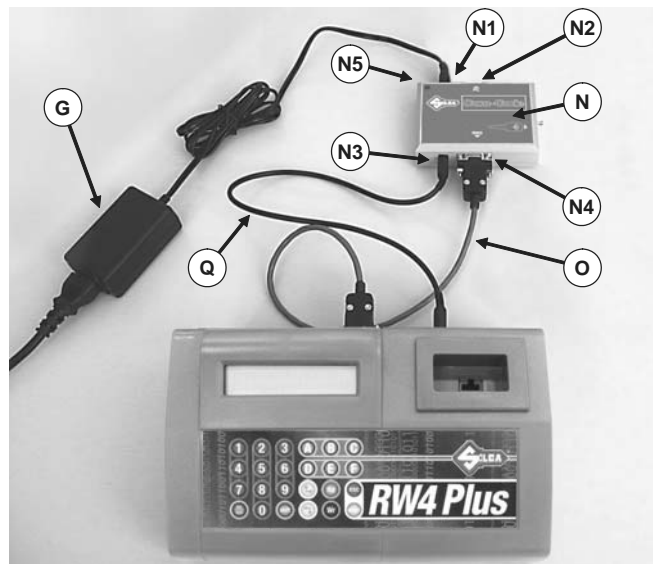

Fig. 6

Machine and module powered by the universal input (with or without connection to a PC).

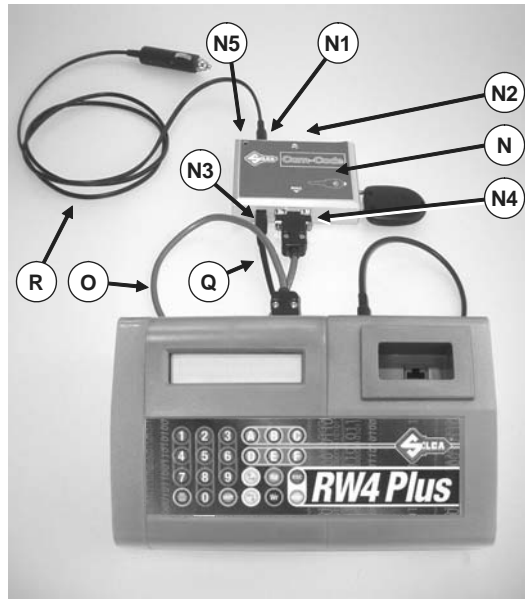

Fig. 7

Machine and module powered from cigarette lighter (with or without connection to personal computer).

#### 6.4 Software upgrade and use with PC

Software for both the machine and the module is upgraded separately and independently through the connections shown in Fig. 8. Use an RS 232 serial cable of less than 3 metres in length or an USB cable and follow the instructions provided with the upgrade cd-rom.

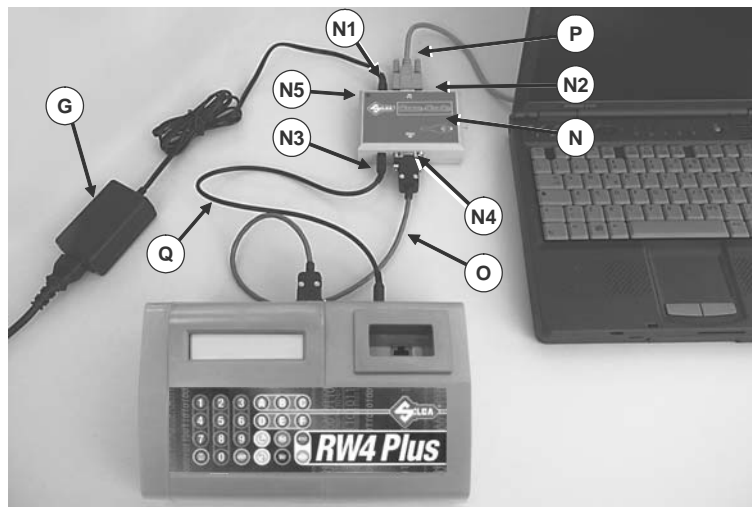

Fig. 8

## 7 USE OF THE MACHINE

This chapter describes all the operations required for copying, identifying, reading and writing a transponder key, including storage in the archive of codes read.

Also described is the use of the Com-Code module for coding Holden Commodore keys.

### 7.1 Turning on

After turning the machine on, the display shows:

*	*	W	A	I	T													*	*	

After a few seconds the display shows:

		C	O	N	N	E	C	T	E	D		T	O		P	C				



If the display shows the words "CONNECTED TO PC", it means the machine is on standby for commands from the personal computer (via serial line or USB) and will be controlled by a personal computer.

Operations cannot take place without a PC.

#### Stand-alone operation

If you wish to use the machine without a PC, press **LOC/REM**.

			V	E	R	.		X	X	.	Y	Y	.	z	z	z				



The wording " VER. XX.YY.ZZZ " indicates the version of the internal program.

### 7.2 Main menu

The display shows the following message, which represents the first two items in the Main menu:

>	C	O	P	Y																
	I	D	E	N	T	I	F	I	C	A	T	I	O	N						

The menu choices are shown on the following screen.

>	C	O	P	Y																
	I	D	E	N	T	I	F	I	C	A	T	I	O	N						
	E	N	T	E	R	I	N	G			C	O	D	E						
	C	O	D	E		G	E	N	E	R	E	T	I	O	N					
	A	R	C	H	I	V	E													
	H	O	L	D	E	N		C	O	M	M	O	D	O	R	E				
	O	P	T	I	O	N	S													



To select use the up/down arrow keys to place the ">" cursor on the word required, then press **ENTER**.

### 7.3 Key copying

This function is activated when "COPY" is selected: the machine is ready to make a copy of the electronic code on the transponder of the original key on one or more transponder key blanks.



### 7.3.1 Key reading

The display shows:

I	N	S	E	R	T	O	R	I	G	I	N	A	L			
K	E	Y													>	R D



Fit the key all the way into the special hole on the front of the machine then confirm that the key must be read by pressing **RD**.

The reading operation begins. For a few seconds the screen shows:

R	E	A	D	I	N	G	I	N	P	R	O	G	R	E	S	S

If there are problems during transponder reading (no transponder, cannot be cut, crypto, reading error, etc.) a warning message appears (see Ch. 8 - WARNINGS).

If the electronic code is read successfully, the screen shows:

R	E	M	O	V	E	K	E	Y								

#### 7.3.1.1 Calculation for Texas\* Crypto transponder (60, 61, 62, 63, 64, 65, 67, 68, 69, 70, XX, 6F)

If a TEXAS\* Crypto transponder is being copied, when the key is removed the display will show:

K	E	Y	D	A	T	A	P	R	O	C	E	S	S	I	N	G
W	A	I	T							x	x	/	9	9	-	



Press ESC to stop the operation.

The number shown from 00 to 99 indicates progression of the calculation. This operation may take up to 15 minutes.

If calculation is not successful, two error conditions may occur:

a)

C	R	Y	P	T	O	T	R	A	N	S	P	.				
C	A	N	N	O	T	D	U	P	L	I	C	A	T	E		

In this case a copy of the original key cannot be made as it CANNOT BE COPIED.

b)

I	N	T	E	R	N	A	L	C	B	O	X	E	R	R	O	R
						C	O	D	=	Y	Y					

In this case an internal error has occurred (COD = YY) in operation of the circuit board dedicated to calculating. Try again. If the problem persists contact the after-sales service, providing the error code shown.

If calculation is successful the device will proceed with the writing operation.

### 7.3.1.2 COPY Philips\* Crypto transponders (42)

When copying a PHILIPS\* Crypto Transponder (42), the original key must be read for 5 to 10 seconds. Do not remove the original key from the reading antenna during the operation; wait for the message (REMOVE KEY) to appear before taking the key from the device.

#### 7.3.1.2.1 Key Regeneration 42

If during the Key ID 42 copying stage the original key is removed before the end of the reading operation a warning message 14 will appear (see ch.8 WARNINGS"). Temporarily the key involved may not start the vehicle (check directly on the vehicle). If so, use the following reset function to allow the key to operate properly:

Select "REGENERATE KEY 42" from the "OPTIONS" menu, the display will show:

I	N	S	E	R	T		O	R	I	G	I	N	A	L			
K	E	Y													>	W	R



Insert the key to be regenerated all the way into the special hole on the machine front, then confirm and press the WR key.

The regeneration operation starts. If no errors have occurred during regeneration, the message below appears:

	K	E	Y	B	L	A	N	K		C	O	R	R	E	C	T	L	Y
	R	E	G	E	N	E	R	A	T	E	D							

The key has now been reset and will operate properly.

In the event of problems during transponder REGENERATION, (no transponder, not copiable, crypto, reading error, etc) a warning message will appear (see ch. 8 WARNINGS).

Press ESC to quit.

### 7.3.1.3 COPY Philips\* Crypto transponders (41)

When copying a PHILIPS\* Crypto Transponder (41), use only Silca keys with T25 transponders. Copies on keys with T11 transponders and original Nissan keys do not work.

**Note 1:** A copy of a PHILIPS\* Crypto Transponder (41) on a transponder by a manufacturer different from Silca may not work.

**Note 2:** It may not be possible to duplicate certain keys with PHILIPS Crypto Transponder (41) (see Ch. 8 - WARNINGS).

### 7.3.1.4 COPY Philips\* Crypto transponders (40)

This function is used to see whether a key with Philips\* Crypto transponder (40) uses a fixed code immobilizer and can therefore be copied onto Silca keys with T5 transponders (see Ch. 7.6.3.2) or uses a crypto code immobilizer and therefore cannot be copied.

	C	O	P	Y													
>	I	D	E	N	T	I	F	I	C	A	T	I	O	N			

	I	N	S	E	R	T		O	R	I	G	I	N	A	L		
	K	E	Y												>	R	D



In the former case, when the key has been read, RW4 Plus will show the following message:

O	P	E	L		T	R	A	N	S	P	.		C	R	Y	P	T	O	
	C	A	N		B	E		D	U	P	.	O	N		T	5		4	0

This means that the key can be used in fixed code mode and therefore be copied onto a Silca key with T5 transponder.

In the latter case, when the key has been read, RW4 Plus will show the following message:

O	P	E	L		T	R	A	N	S	P	.		C	R	Y	P	T	O	
	C	A	N	N	O	T		D	U	P	L	I	C	A	T	E		4	0

---

**Nota:** correct identification of keys that can be copied onto T5 or cannot be copied is guaranteed only if the keys read are originals or produced by Silca.

---

### 7.3.1.5 Copy Philips\* Crypto transponder (4W)

Some Volkswagen group models produced between 2000 and 2006 ca. use a Philips Crypto transponder identified by RW4 Plus with ID=4W.

For some of these models (depends on the case), RW4 Plus can be used to make an operational copy of the original key.

As it cannot be known in advance whether the key can be copied, first use the RW4 Plus IDENTIFICATION function. When this operation is complete, the machine display may show:

T	R	A	N	S	.		V	A	G		C	R	Y	P	T	O			
	C	A	N	N	O	T		D	U	P	L	I	C	A	T	E		4	W

or:

T	R	A	N	S	.		V	A	G		C	R	Y	P	T	O			
C	A	N		B	E		D	U	P	L	I	C	A	T	E	D		4	W

In the first case a non-copiable transponder number (4W) has been read; in the second case a copiable transponder (4W) has been read and you can make a copy on a Silca key with T28 transponder.

**Nota 1:** copies of Philips Crypto transponders (4W) on keys with T15 transponders or on original keys do not work.

**Nota 2:** copies of Philips Crypto transponders (4W) on transponders by manufacturers different from Silca may not work.

### 7.3.1.6 Copy Philips\* Crypto transponder (45)

When copying a PHILIPS\* Crypto transponder (45), the reading of the original key may take several seconds. The machine display shows the following message:

	R	E	A	D	I	N	G		I	N		P	R	O	G	R	E	S	S
	W	A	I	T														*	

take care **not to remove the original key from the reading antenna during this operation;** always wait for the message (REMOVE KEY) before removing the key:

	R	E	M	O	V	E		K	E	Y									

### **VERY IMPORTANT!**

If the key is removed before the machine has finished all the operations, the following message will appear:

	R	E	A	D	I	N	G		E	R	R	O	R					
	R	E	G	E	N	E	R	A	T	E		K	E	Y		4	5	

at this point the key is momentarily unable to start the vehicle. In this situation **before carrying out any other operation** you must use the function "Regenerate Key 45" (see Ch 7.3.1.6.1).

### 7.3.1.6.1 Regenerate Key 45

If during the key ID (45) copying stage, or when the PINCODE is being read, the key is removed before the reading operation is finished, warning message 14 will appear (see ch. 8 WARNINGS).

At this point the key is momentarily unable to start the vehicle. In this situation before carrying out any other operation you must use the following reset function to allow the key to operate properly:

When "RIGENERATE KEY 45" has been selected from the "OPTIONS" menu, the display will show:

I	N	S	E	R	T		O	R	I	G	I	N	A	L			
K	E	Y													>	W	R

Insert the key to be regenerated all the way into the special hole on the front part of the machine, press the WR button to confirm your desire to proceed; the display will show:

R	E	G	E	N	E	R	A	T	E		K	E	Y			4	5
W	A	I	T														Ж

this operation may last several seconds; wait until the display shows:

K	E	Y	B	L	A	N	K		C	O	R	R	E	C	T	L	Y
R	E	G	E	N	E	R	A	T	E	D							

the key has now been regenerated and will operate properly.

### 7.3.1.7 COPY Texas\* Crypto2 (6F) transponder

One of the features of second generation Texas\* Crypto transponders is that they are retro-compatible with first generation Texas\* Crypto transponders; this has made it possible for some vehicle manufacturers to use second generation Texas\* Crypto transponders in vehicle control units with a first generation Texas\* Crypto system that use only part of the electronic code to start the engine.

In this case only part of the potential of the second generation Texas\* Crypto transponder is used, because the control unit on the vehicle uses it in retro-compatible mode. This allows vehicle makers to use only second generation Texas\* Crypto transponder on original keys and original spares, whether they are used fully or partially.

It is therefore possible to copy a key with second generation Texas\* Crypto transponder (type 6F) onto a Silca EH2 key.

**If you are sure that the vehicle control unit works in compatible mode with a first generation Texas\* Crypto transponder, part of the electronic code can be copied onto a Silca EH2 key to make a key that works. If this is not the case, the key will not work at all.**

When trying to copy this type of key, the RW4 Plus machine will show a warning message:

T	E	X	A	S		T	R	A	N	S	P	.		C	R	Y	P	T	O
T	Y	P	E			6	F	-	*	*						>	E	N	T

indicating that a second generation 6F type Texas\* Crypto transponder has been detected. To continue, press "Enter" and the message will appear:

E	X	E	C	U	T	E		C	O	P	Y	?							
						N	O	>	E	S	C		Y	E	S	>	E	N	T

Press "esc" to abandon the copying process and go back to the main menu. Press "enter" to continue with copying and start the calculation for Texas\* Crypto transponder (see paragraph 7.3.1.7)

**NOTE:** A copy of a second generation Texas\* Crypto transponder on a Silca EH2 key will be detected as a first generation Texas\* Crypto key, see Ch. 7.6.4 and 7.6.4.1.

### 7.3.1.8 COPY Philips\* Crypto2 (46) transponder

The main characteristic of Philips\* Crypto second generation transponders is that they employ a mutual authentication method with the vehicle on which they are used. In other words, differently from most other transponders, not only the vehicle control unit checks the data on the transponder, but the transponder also checks the data required by the vehicle; only after having checked the requirement, it transmits the information needed by the immobilizer system to allow engine ignition.

To make a copy of a Philips\* Crypto second generation transponder, you need to read the data exchanged by the transponder and immobilizer control unit through the vehicle starter. The operation can be easily performed (as described below) with the SNOOP (OPTIONAL) device applied to the original key.

**Described below is the procedure for making a copy of a Philips\* Crypto2 transponder:**

#### STAGE 1: Reading the original key and initializing the SNOOP.

From the machine COPY menu, when required insert the original key and press "Rd":

I	N	S	E	R	T			O	R	I	G	I	N	A	L		
K	E	Y															

Rd

The machine reads the key and after a few seconds the display shows:

R	E	M	O	V	E			K	E	Y							

When the key has been removed instructions are given to insert Snoop:

I	N	S	E	R	T			S	N	O	O	P					

enter

When "Enter" is pressed the machine makes some operational checks on SNOOP. If it finds data from a previously copied key the display will show:

R	E	S	E	T		S	N	O	O	P	?						
N	O																

enter

If you do not want to overwrite the data from a previously used key, press "ESC". The machine will return to the main menu. To continue press "Enter"; the display will show:

P	L	E	A	S	E			W	A	I	T	.	.	.			

Then automatically:

R	E	M	O	V	E			S	N	O	O	P					

When the SNOOP has been removed the display will show:

W	A	I	T	I	N	G		S	N	O	O	P		D	A	T	A
E	X	I	T														

SNOOP has now been initialized to read the data exchange between the vehicle and the original key (see Stage 2).

**Note:** When "ESC" is pressed the machine will return to the main menu so that other operations can be carried out. The copying process for the current key can be resumed later (see STAGE 3 variant B).

## STAGE 2: Reading data from vehicle.

When the SNOOP has been initialized, make two ignitions of the vehicle control panel with the key used in STAGE 1.

To perform this operation place the SNOOP antenna in position as shown in the figures below:

### Placing the antenna in position on the key (for use on the vehicle only):

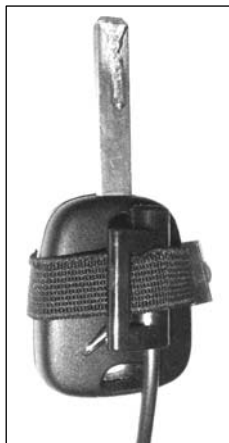

The SNOOP antenna must be attached to the centre of the head on the key to be copied. See illustration on left. Secure the antenna to the key with the elastic band (D).

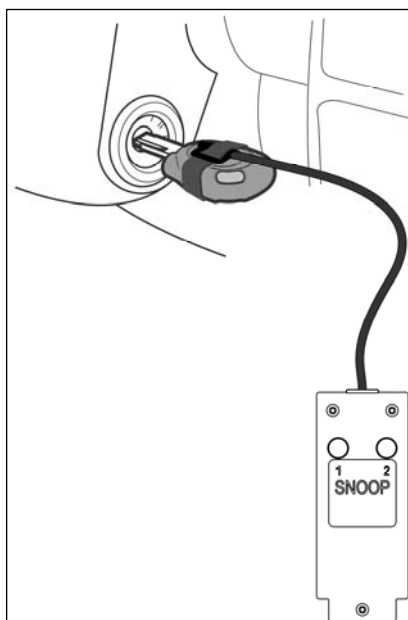

### Use on the vehicle:

Insert the key complete with the SNOOP antenna into the vehicle starter.

Turn on the vehicle control panel. LED "1" on SNOOP will flash for a few seconds to indicate that the first data reading operation has been successful.

When LED "1" goes out, turn off the control panel and remove the key.

Wait 10-20 seconds or until the immobilizer warning light starts flashing, if applicable.

Insert the key into the vehicle starter again.

Turn on the vehicle control panel. LED "1" on SNOOP will go on and LED "2" will flash for a few seconds to indicate that the second reading operation has been successful. Both LEDs will go out.

SNOOP now has the necessary data to transmit to the machine for a copy of the original key. Turning on the vehicle control panel again will put the SNOOP LEDs on permanently, which indicates that all necessary data has been downloaded.

If there are problems during datalogging (LEDs do not go on) try:

- Place the Snoop antenna in such a position that when the key is inserted into the ignition unit the antenna can be moved away from or closer to the unit.
- Waiting 15-30 seconds between ignitions (in some cases the wait could be up to a couple of minutes).
- Closing and opening the vehicle doors using the key control.
- Starting the engine for a few seconds.

Note: On some vehicles data is downloaded by simply inserting the key into the starter. In such cases the SNOOP LEDs illuminate. In these circumstances just insert and remove the key in the starter twice.



#### STAGE 4: Reading and copying the original key

After inserting the original key and pressing “RD”:

	I	N	S	E	R	T			O	R	I	G	I	N	A	L			
	K	E	Y														>	R	D



The calculating process for reading an original key begins.

	C	A	L	C	U	L	A	T	I	N	G							
	W	A	I	T								X	X	/	9	9		



Press ESC to interrupt the operation.

The number shown from 00 to 99 indicates that calculation is taking place. The operation could take anything from a few seconds to 3 minutes.

**During this operation leave the key in the machine.**

At the end of the calculating process the machine will require the key to be removed:

	R	E	M	O	V	E			K	E	Y						

When the original key has been removed you will be required to insert an EHP key:

	I	N	S	E	R	T			E	H	P							
	K	E	Y													>	W	R



Insert the EHP electronic key. Press “WR” to confirm key writing. Checking starts on the key transponder (compatibility).

If problems occur when checking the electronic key (incompatible key, missing, wrong, unwritable transponder, etc) a warning message will appear, see paragraph: “Warning messages when copying a Philips\* CR/2” transponder, or Chapter 8 – “WARNING MESSAGES”.

The writing operation begins. For a few seconds the display shows the message:

	W	R	I	T	I	N	G		I	N		P	R	O	G	R	E	S	S
		W	A	I	T	.	.	.											

If writing is successful the following appears:

	O	P	E	R	A	T	I	O	N		C	O	M	P	L	E	T	E	D

If problems occur when writing the transponder (writing error) a warning message appears: see paragraph “Special events that could occur when copying a Philips\* CR2 transponder”, or Chapter 8 – “WARNING MESSAGES”.

After a few seconds you will be asked if other copies are to be made of the key with the same code:

	O	T	H	E	R		C	O	P	I	E	S	?						
						N	O	>	E	S	C		Y	E	S	>	E	N	T



- press “ESC” to continue without making other copies
- press “ENTER” to make another copy.



In this case the machine repeats the writing cycle (no need to insert the original key or recalculate).

## 7.4 Writing a key

After removing the key, the display shows:

I	N	S	E	R	T	B	L	A	N	K	K	E	Y		
													>	W	R



Fit the key with the uncoded transponder, then confirm that the key must be written by pressing **WR**.

This starts the operation to check whether the transponder on the key is compatible with the type of transponder previously read.

If there are problems when checking the transponder, (no transponder, wrong, cannot be written, crypto, etc) a warning message will appear (see Ch. 8 - WARNINGS).

The writing operation begins. For a few seconds the display shows:

	W	R	I	T	I	N	G		I	N		P	R	O	G	R	E	S	S	

If writing is successful, the display shows:

	O	P	E	R	A	T	I	O	N		C	O	M	P	L	E	T	E	D

If there are problems when writing the transponder (writing error) a warning message will appear (see chapter 8 - WARNINGS).

After a few seconds the machine will ask whether other copies must be made with the same code; the display shows:

	O	T	H	E	R		C	O	P	I	E	S	?						
						N	O	>	E	S	C		Y	E	S	>	E	N	T



- Press **ESC** to continue without making other copies;
- Press **ENTER** to make another copy.

In this case the machine repeats the writing cycle, etc.

## 7.5 Memorizing the code

After making one or more copies the machine asks if the electronic code read should be stored in the archive so that it can be used again to make a new key, or to transfer it to a personal computer. The display shows:

	M	E	M	O	R	I	Z	E			C	O	D	E	?			
				N	O	>	E	S	C		Y	E	S	>	E	N	T	



- Press **ESC** to continue without memorizing;
- Press **ENTER** to memorize the code.

If the code is to be memorized, the display shows:

C	C	C	C	C	C	C	C		C	C	C	C	C	C	C		X	X
C	C	C	C	C	C	C	C		C	C	C	C	C	C	C		N	N



### Meaning of data shown

- **CCCC... CCCC**: transponder electronic code
- **XX**: ID number for type of transponder
- **NN**: position assigned to the code in the memory (progressive number)
- Press **ESC** to continue.
- The display shows:

	R	E	M	O	V	E		K	E	Y								

After the key has been removed the cycle starts again from the beginning.

## 7.6 Transponder identification

This function is enabled by selecting the IDENTIFICATION function: the machine is ready to check the type of transponder (Philips\*, Megamos\*, Temic\*, Texas\*) on the key.

### Type of transponder

The number in brackets, e.g. (33), indicates the type of transponder read on the key and is a useful piece of information for the after-sales service in order to identify transponder anomalies or malfunctions.

Type of transponder	number
SILCA blank	(21)
SILCA blank	(22)
SILCA blank	(23)
SILCA blank	(17)
TEMIC* (Fiat)	(11)
TEMIC* (Mazda)	(12)
MEGAMOS*	(13)
PHILIPS* (orig. or emul.)	(33)
PHILIPS* (orig.)	(73)
PHILIPS* emulating MEGAMOS* (Audi)	(53)
PHILIPS* emulating MEGAMOS* (VDO)	(93)
PHILIPS* Crypto	(44)
MEGAMOS* Crypto	(48)
TEXAS*	(4C)
TEXAS* Crypto	(60)
TEXAS* Crypto MITSUBISHI 3	(61)
TEXAS* Crypto MITSUBISHI 2	(62)
TEXAS* Crypto FORD 2	(63)
TEXAS* Crypto (RENAULT < 2000, CHRYSLER, JEEP)	(64)
TEXAS* Crypto (SUZUKI)	(65)
TEXAS* Crypto (SUZUKI – 2 Type)	(66)
TEXAS* Crypto (TOYOTA/LEXUS)	(67)
TEXAS* Crypto (TOYOTA/LEXUS2)	(68)
TEXAS* Crypto (YAMAHA)	(69)
TEXAS* Crypto (TOYOTA EU)	(70)
TEMIC* Crypto	(8C)
SAAB not duplicable	(8D)
SOKYMAT* CRYPTO (HONDA - AUDI 2007)	(8E)
PHILIPS* Crypto OPEL	(40)
PHILIPS* Crypto NISSAN	(41)
PHILIPS* Crypto VAG	(42)
PHILIPS* Crypto VAG	(4W)
PHILIPS* Crypto MITSUBISHI-VOLVO	(4M)
PHILIPS* Crypto FIAT GRP	(4F)
PHILIPS* Crypto PEUGEOT	(45)
PHILIPS* Crypto 2	(46)
TEXAS* Crypto 2	(6F)
MEGAMOS* Crypto VOLKSWAGEN	(A1)
MEGAMOS* Crypto AUDI	(A2)
MEGAMOS* Crypto SEAT	(A3)
MEGAMOS* Crypto SKODA	(A4)

If the display shows the warning message "TRANSPONDER CRYPTO", the key in question contains a transponder with a code that cannot be cut (cannot be written).

### 7.6.1 Reading code and type of transponder (ID)

The display shows:

I	N	S	E	R	T	O	R	I	G	I	N	A	L			
K	E	Y												>	R	D



Fit the original key into the special hole and press **RD**; the reading operation starts. For a few seconds the display shows:

R	E	A	D	I	N	G	I	N	P	R	O	G	R	E	S	S

If there are problems when reading the transponder (no transponder, reading error, cannot be cut, crypto) a warning message appears (see chapter 8 - "WARNINGS").

If the electronic code has been read successfully, the display shows:

C	C	C	C	C	C	C	C	C	C	C	C	C	C	C	C	X	X
C	C	C	C	C	C	C	C	C	C	C	C	C	C	C	C	N	N



- **CCC.... CCCC**: transponder electronic code
- **XX**: ID number of type of transponder
- **NN**: position assigned to the code in the memory (progressive number)
- Press **ESC** to continue without memorizing
- Press **ENTER** to memorize.

#### Electronic codes from Megamos\* and Temic\* transponders.

Due to the special reading system used, the same key can be read from different random points of the code, showing codes that are apparently different. However, the code is valid as it will be recognised correctly by the vehicle central control unit, which will begin reading from the point foreseen and not at random.

### 7.6.2 Memorizing a code

If code memorization is required (**ENTER**), the display shows:

K	E	Y	M	E	M	O	R	I	Z	E	D				



Press **ESC** to go back to the beginning.

### 7.6.3 Philips\* Crypto Transponder (40, 41, 42, 44, 45, 4W, 4M, 4F)

When a key with a "Philips\* Crypto" transponder is fitted into the machine using the "Identification" menu, the display will show the relative ID codes.

I	N	S	E	R	T	O	R	I	G	I	N	A	L			
K	E	Y												>	R	D

Press the "Rd" button to view the following message on the display:

T	R	A	N	S	.	B	B	B	B	B	C	R	Y	P	T	O	
D	D	D	D													X	X

### Meaning of data:

BBBB: indicates the name or initials of the vehicle manufacturer

DDDD: indicates whether the transponder can be copied or not

XX: Identification number of the type of transponder (ID).

T	R	A	N	S	.		B	B	B	B	B	C	R	Y	P	T	O	
	D	D	D	D													X	X



Press the "ENTER" key to see on the display some of the data for the transponder just read; this function can be useful for checking copying of original keys with Philips\* Crypto transponders.

	I	D	E	:	*	*	*	*	*	*	*	*						



IDE is an eight-digit code to identify Philips\* Crypto transponders.

In some cases this code is hidden and the machine display will show:

No IDE

From here, press the "arrow down" key to see:

C	C	C	C	C	C	C	C		C	C	C	C	C	C	C	C	X	X
C	C	C	C	C	C	C	C		C	C	C	C	C	C	C	C	N	N



- CCC...CCC: Electronic transponder code <sup>(1)</sup>
- XX: identification number of the type of transponder (ID)
- NN: position assigned to the code in the memory (progressive number).
- to continue without memorizing, press **ESC**;
- to memorize, press **ENTER** <sup>(2)</sup>.

- (1) in some cases a copy of just the electronic code on Silca T5 transponder can be used to make keys that will operate on the vehicle, see chapter 7.6.3.2.
- (2) only the electronic code on the transponder is memorized.

### 7.6.3.1 Reading PINCODE on Philips\* Crypto Transponder (45)

RW4 Plus is able to read the PINCODE valid for programming new keys with the diagnostics device on PEUGEOT vehicles that use keys with PHILIPS\* Crypto transponders (45).

This function is accessible from the "IDENTIFICATION" menu. When the electronic transponder code is viewed (see paragraph 7.6.3) press "arrow down":

C	C	C	C	C	C	C	C		C	C	C	C	C	C	C	C	4	5
C	C	C	C	C	C	C	C		C	C	C	C	C	C	C	C	N	N

when "arrow down" has been pressed, the display will show:

P	R	E	S	S			>	W	R		T	O						
R	E	A	D	I	N	G		P	I	N		C	O	D	E			



Press "WR" to begin the PINCODE reading process. The reading operation may last several seconds. The machine display will show the following message:

	R	E	A	D	I	N	G		I	N		P	R	O	G	R	E	S	S
	W	A	I	T													*		

take care **not to remove the original key from the reading antenna during this procedure**, always wait until the operation is finished and RW4 PLUS shows the result:

	P	I	N		C	O	D	E	:										
										P	P	P	P						

- PPPP: vehicle PINCODE.

## VERY IMPORTANT!

If the key is removed before the machine has finished all the operations, the following message will appear:

	R	E	A	D	I	N	G		E	R	R	O	R						
	R	E	G	E	N	E	R	A	T	E		K	E	Y			4	5	

at this point the key is momentarily unable to start the vehicle. In this situation **before carrying out any other operation** use the "Regenerate Key 45" function, see chap. 7.3.1.6.1.

### 7.6.3.2 Copying the ID of Philips\* Crypto Transponders (40<sup>(1)</sup>, 44)

One of the characteristics of Philips\* Crypto transponders is that of being retro-compatible with Philips\* fixed code transponders. This has made it possible for some vehicle manufacturers to use Philips\* Crypto transponders in the central control unit of vehicles with **fixed code** (not crypto) systems that use only part of the electronic code to turn on the engine.

In this case the potential of Philips\* Crypto transponders is used only partially because the vehicle central control unit is unable to read and use the hidden part of the code (Crypto). However, it allows automobile manufacturers to use only Philips\* Crypto transponders on its original spare keys, then it can be used fully (if it goes with a vehicle that has a Crypto type central control unit), or partially, reading only the electronic code.

It is therefore only possible to copy just the electronic code of a Philips\* Crypto transponder onto a Silca T5.

---

**Note: this operation must be carried out only after ascertaining that the vehicle central control unit is a fixed code type (the information may be provided by the owner, the dealer, or found on the basis of the year of registration), otherwise the key obtained will not work.**

---

<sup>(1)</sup> For Philips\* Crypto transponders identified with ID (40) used on some Opel and General Motors models, RW4 is able to indicate whether they are used with fixed code or crypto mode (see chapter 7.3.1.2).

#### How to copy:

Start from the "Copy" menu; if the following message appears after reading the original key:

	T	R	A	N	S	P	O	N	D	E	R		C	R	Y	P	T	O	
	C	A	N	N	O	T		D	U	P	L	I	C	A	T	E		4	4

enter

Press "ENTER" and the display will show:

	C	O	P	Y		I	D		?											
						N	O	>	E	S	C			Y	E	S	>	E	N	T

enter

- To continue without making a copy, press "ESC";
- To make a copy press "ENTER".

## 7.6.4 Texas\* Crypto Transponder (60, 61, 62, 63, 64, 65, 66, 67, 68, 69, 70)

When a key with a "Texas\* Crypto" transponder is placed in the machine, use the "Identification" menu to view the relevant ID codes on the display.

The display shows the message:

T	E	X	A	S		T	R	A	N	S	P	.		C	R	Y	P	T	O
T	Y	P	E						X	X								N	N



Meaning of the data shown:

XX : ID number for the type of transponder.

NN: position assigned to the data read in the memory (progressive number).

- Press **ESC** to continue without memorizing.
- press **ENTER** to memorize.

---

**N.B:** if two asterisks are shown "\*\*\*\*" in the place of transponder ID, the transponder being read is not known to the machine.

---

T	E	X	A	S		T	R	A	N	S	P	.		C	R	Y	P	T	O
T	Y	P	E						*	*								N	N



If the "ENTER" key is pressed the display shows some data about the transponder just read. This function may be useful if the transponder to be read is new and not yet identified. Please transmit these data to the Silca after-sales service (to facilitate the operation the data can be saved in the machine memory).

P	W		*	*		I	D		*	*								X	X
M	C		*	*		*	*	*	*	*	*		*	*				N	N



XX : ID number for the type of transponder

NN : position assigned to the data read in the memory (progressive number).

All the other indications on the display are data read from the transponder.

- press **ESC** to continue without memorizing.
- press **ENTER** to memorize.

### 7.6.4.1 Texas\* Crypto2 (6F) Transponder

When a key with a "Texas\* Crypto2" transponder is placed in the machine, use the "Identification" menu to view the relevant ID codes on the display.

The display shows the message:

T	E	X	A	S		T	R	A	N	S	P	.		C	R	Y	P	T	O
T	Y	P	E			6	F	-	*	*								N	N

Meaning of the data shown:

**6F**: primary ID number, 6F indicates a "Texas\* Crypto2" transponder

**XX**: secondary ID number, indicates the type of application for the transponder; may take values of 60, 61, 62, 63, 64, 65, 66, 67, 68, 69 (see Ch. 7.6)

**NN**: position assigned to the data read in the memory (progressive number).

- Press **ESC** to continue without memorizing.
- press **ENTER** to memorize.

---

**N.B:** if two asterisks "\*\*\*\*" appear in the place of the secondary ID, the transponder being read by the machine is unknown.

---

T	E	X	A	S		T	R	A	N	S	P	.		C	R	Y	P	T	O	
T	Y	P	E			6	F	-	*	*									N	N



If the "ENTER" key is pressed the display shows some data about the transponder just read.

C	C	C	C	C	C	C	C	C	C	C	C	C	C		6	F	-	X	X
C	C	C	C	C	C	C	C	C	C	C	C	C	C					N	N

**6F**: primary ID number, 6F indicates a "Texas\* Crypto2" transponder

**XX**: secondary ID number

**CCC...CCC**: Transponder electronic code

**NN**: position assigned to the data read in the memory (progressive number).

All the other indications on the display are data read from the transponder.

- press **ESC** to continue without memorizing.
- press **ENTER** to memorize.



## 7.6.5

### Electronic Key (Texas)

When a key containing a Silca EH2 electronic head is inserted into the machine, use the "Identification" menu to view on the display the relevant ID codes.

The display will show the message:

I	N	S	E	R	T		O	R	I	G	I	N	A	L			
K	E	Y													>	R	D



Put the key into the special hole and press the **RD** button; the reading operation will begin. The following message will appear for a few seconds.

R	E	A	D	I	N	G		I	N	P	R	O	G	R	E	S	S

If there are problems when the key is being read (key missing, reading error, flat battery) a warning message will appear (see Ch. 8 - "WARNINGS").

If the electronic code has been read properly, the message will appear:  
(Texas\* Fixed Code Emulation or Texas\* Crypto Code Emulation)

#### TEXAS\* FIXED CODE EMULATION

If the electronic key is an emulation of a fixed code Texas\* transponder the display will show the message:

C	C	C	C	C	C	C	C		C	C	C	C	C	C	Y	Y	X	X
C	C	C	C	C	C	C	C		C	C	C	C	C	C	C		N	N



- **CCC... CCCC**: transponder electronic code
- **XX**: identification number of type of transponder (ID)
- **YY**: version of electronic key (for versions over 38 only)
- **NN**: position in memory assigned to code (progressive number).
- To continue without memorizing press the **ESC** key;
- To memorize, press the **ENTER** key.

#### TEXAS\* CRYPTO CODE EMULATION

If the electronic key is an emulation of a Texas CRYPTO code the display will show the message:

T	E	X	A	S		T	R	A	N	S	P	.		C	R	Y	P	T	O
T	Y	P	E						X	X		Y	Y					-	-



The data shown means:

**XX**: identification number of type of transponder (ID).  
**YY**: version of electronic key (for versions over 38 only)

- To continue press the **ESC** key.
- to memorize, press the **ENTER** key.

## 7.6.6 Electronic Key (PHILIPS CR2)

When a key containing a Silca EHP electronic head is inserted into the machine, use the "Identification" menu to view on the display the relevant ID codes.

The display will show the message:

I	N	S	E	R	T		O	R	I	G	I	N	A	L			
K	E	Y													>	R	D



Put the key into the special hole and press the **RD** button; the reading operation will begin. The following message will appear for a few seconds:

R	E	A	D	I	N	G		I	N		P	R	O	G	R	E	S	S

If there are problems when the key is being read (key missing, reading error, flat battery) a warning message will appear (see chap. 8- "WARNINGS").

If the electronic code has been read properly, the message will appear:

T	R	A	N	S	P	.		P	H	-	C	R	2				4	6	
E	H	P														>	E	N	T



If the "ENTER" key is pressed:

C	C	C	C	C	C												4	6	
																>	E	N	T



– CCCCCC: transponder electronic code

If the "ENTER" key is pressed:

E	H	P	:	A	A	A	A	A	A	A						v	.	X	X
0	0	0	0		0	0	0		0									N	N

- EHP: AAAAAAAA identification number EHP
- v.XX: version of electronic key
- NN: position in memory assigned to code (progressive number)

## 7.7 Copy by known code

A transponder key can be copied if the electronic code is known.

This function copies a key from the code entered by the user and is activated by selecting "ENTER CODE".

The display shows the first two items in the sub-menu; the possible choices are shown below:

O	R	I	G	I	N	A	L	T	R	A	N	S	P	O	N	D	E	R
>	M	E	G	A	M	O	S	1	3	-								
	P	H	I	L	I	P	S	3	3	-	7	3						
	P	H	I	L	I	P	S	5	3	-	9	3						
	T	E	M	I	C			1	1	-								
	T	E	M	I	C			1	2	-								
	T	E	X	A	S			4	C									



Numbers 13, 33, 73, 40, 41, 42, 44, 45, 53, 93, 11, 12, 4C indicate the type of transponder.

Select the original type of transponder from which the code to be copied has been read, then press **ENTER**.

### 7.7.1 Entering the code

The transponder electronic code is made up of numbers from 0 to 9 and letters A B C D E F.

When PHILIPS\* is selected the display shows 2 fields of 16 characters.

-	-	-	-	-	-	-	-	-	-	-	-	-	-	-	-	-	-	-
-	-	-	-	-	-	-	-	-	-	-	-	-	-	-	-	-	-	-

When MEGAMOS\* or TEMIC\* are selected the display shows 1 field of 16 characters.

-	-	-	-	-	-	-	-	-	-	-	-	-	-	-	-	-	-	-



When TEXAS\* 4C is selected the display shows 1 field of 28 characters.

-	-	-	-	-	-	-	-	-	-	-	-	-	-	-	-	-	-	-	-	-	-	-	-	-	-	-	-	
-	-	-	-	-	-	-	-	-	-	-	-	-	-	-	-	-	-	-	-	-	-	-	-	-	-	-	-	-



Digit the code then press **ENTER**.

To alter a wrongly entered number, use the **SHIFT and LH/RH ARROWS** to move into the position to correct; press **ENTER**.

The machine makes a check of special code fields; if the number is not correct a warning message appears:

	I	N	C	O	R	R	E	C	T		C	O	D	E															



- Press ESC to quit, then repeat.

\* Megamos, Philips, Temic, Texas are registered trademarks.

## 7.7.2 Key writing

If the code entered is correct the display shows:

	I	N	S	E	R	T		B	L	A	N	K		K	E	Y			
																>	W	R	



Fit the uncoded transponder key, press **WR**.

A check is made on the key blank transponder.

If there are problems when checking the transponder (no transponder, wrong, cannot be written, crypto) a warning message appears (see Ch. 8 - WARNINGS).

The writing operation will start. For a few seconds the display shows:

	W	R	I	T	I	N	G		I	N		P	R	O	G	R	E	S	S

If writing is successful, the display shows:

	O	P	E	R	A	T	I	O	N		C	O	M	P	L	E	T	E	D

If there are problems in writing the transponder (writing error) a warning message appears (see Ch. 8 - WARNINGS).

After a few seconds the machine asks whether to make other copies of the key; the display shows:

	O	T	H	E	R		C	O	P	I	E	S	?						
						N	O	>	E	S	C		Y	E	S	>	E	N	T



- press **ESC** to continue without making other copies;
- press **ENTER** to make another copy.

## 7.8 Code generation

If you do not possess the original key or code to copy a transponder key, automatic CODE GENERATION by RW4 Plus can be used. The electronic code is calculated automatically by software that follows the structure of the original code (specific for each vehicle make).

In this way a valid key can be made that is ready to be memorized in the vehicle central control unit.

When the electronic code of the key has been generated the key must be programmed in the vehicle central control unit by means of a specific programming procedure (see SDD PROGRAMMING SECTION column 15, 27 or CAR KEYS SECTION column 15,16 in the transponder guide).

This function is activated by selecting "CODE GENERATION".

The display shows the first two items in the sub-menu; the possible choices are shown below:

	C	O	D	E		G	E	N	E	R	A	T	I	O	N				
>	(	B	-	F	)		B	O	S	C	H	-	F	I	A	T			
	(	M	E	G	)		M	E	G	A	M	O	S						
	(	M	-	V	)		M	E	G	A	M	O	S	-	V	D	O		
	(	T	-	F	)		T	E	M	I	C	-	F	I	A	T			
	(	S	-	O	)		S	I	E	M	E	N	S	-	O	P	E	L	
	(	S	-	V	)		S	I	E	M	E	N	S	-	V	W			
	(	G	-	V	)		P	S	A		V	A	L	E	O				
	(	G	-	C	)		P	S	A		C	H	P						
	(	G	-	N	)		N	I	S	S	A	N							



Select the type of generation using as a reference the generation associated to the vehicle model (see "SDD PROGRAMMING SECTION" column 12, or "CAR KEYS SECTION" column 12 in the transponder guide), and press ENTER.

The display shows the code to be written:

X	X	X	X	X	X	X	X		X	X	X	X	X	X	X	X		X	X
X	X	X	X	X	X	X	X		X	X	X	X	X	X	X	X		X	X



– Press ENTER to continue, ESC to quit:

	I	N	S	E	R	T		B	L	A	N	K		KEY					
															>	W	R		



Fit the key all the way into the special hole on the vehicle control panel, then confirm that the key must be written by pressing **WR**.

If there are problems when checking the transponder (no transponder, wrong, cannot be written, crypto) a warning message appears (see chapter 8 - WARNINGS).

The writing operation will begin. For a few seconds the display shows:

	W	R	I	T	I	N	G		I	N		P	R	O	G	R	E	S	S

If writing is successful, the display shows:

	O	P	E	R	A	T	I	O	N		C	O	M	P	L	E	T	E	D

If there are problems when writing the transponder (writing error) a warning message appears (see chapter 8 - WARNINGS).

After a few seconds the machine will ask whether to make other copies of the key with the same code; the display shows:

	O	T	H	E	R		C	O	P	I	E	S	?						
					N	O	>	E	S	C		Y	E	S	>	E	N	T	



- press **ESC** to continue without making other copies;
- press **ENTER** to make another copy.

## 7.9 Code archive

Up to 99 codes for transponder keys can be stored in the machine's memory.

After reading and memorizing a code in the archive at position "NN", this function is used to gain access to the archive, recover and view the code and decide whether to use it for making other copies.

### 7.9.1 Viewing codes in the archive

This function is activated by selecting "ARCHIVE". The display shows:

	D	I	S	P	L	A	Y		C	O	D	E							
	P	O	S	I	T	I	O	N	?								>	N	N



Enter the required "NN" position in the memory and press **ENTER**.

If there is no code in the "NN" position, the display shows:

	N	O		C	O	D	E		A	T									
	P	O	S	I	T	I	O	N										N	N



- press **ESC** to go back to the beginning.

If there is a transponder code in the "NN" position, the display shows:

C	C	C	C	C	C	C	C		C	C	C	C	C	C	C	C		X	X
C	C	C	C	C	C	C	C		C	C	C	C	C	C	C	C		N	N



- press **ESC** to continue without making a copy.
- press **ENTER** to make a copy from this code.

---

**Note: when the archive is full (100 codes memorized) the message in position NN is: ==**

---

C	C	C	C	C	C	C	C		C	C	C	C	C	C	C	C		X	X
C	C	C	C	C	C	C	C		C	C	C	C	C	C	C	C		=	=



In this case new codes cannot be memorized:

delete the archive so that other codes can be memorized.

## 7.9.2 Writing keys

The display shows:

	I	N	S	E	R	T		B	L	A	N	K		K	E	Y			
																	>	W	R



Fit the uncoded transponder key and press **WR**.

If there are problems when checking the transponder, a warning message appears (see chapter 8 - WARNINGS).

The writing operation begins. For a few seconds the display shows:

	W	R	I	T	I	N	G		I	N		P	R	O	G	R	E	S	S

If writing is successful, the display shows:

	O	P	E	R	A	T	I	O	N		C	O	M	P	L	E	T	E	D

If there are problems when writing the transponder (writing error), a warning message appears (see chapter 8 - WARNINGS).

After a few seconds the machine will ask whether to make other copies; the display shows:

	O	T	H	E	R		C	O	P	I	E	S	?						
						N	O	>	E	S	C		Y	E	S	>	E	N	T



- press **ESC** to continue without making other copies;
- press **ENTER** to make another copy.

## 7.10 Holden Commodore

This function is used when the module for copying or coding Holden-Commodore keys is connected to the machine.

When this function is selected, the display shows the two items in the menu for this type of key.

>	C	O	P	Y														
	E	N	T	E	R	I	N	G		C	O	D	E					

Select the item required and press **ENTER**.

### 7.10.1 Copy

**ATTENTION:** Before activating selection by pressing **ENTER**, fit the original key to be copied into the module, making sure that there is contact between the terminal on the key and the sprung contact on the module through which communication of the code takes place (see Fig. 9).

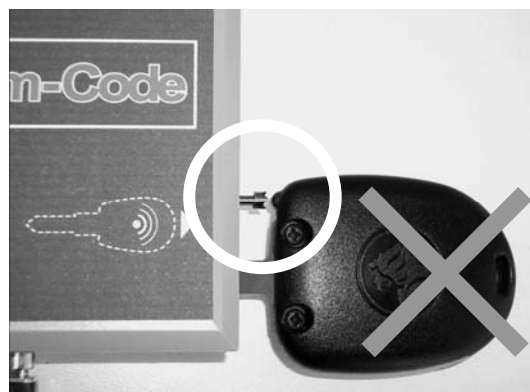

**NO!**

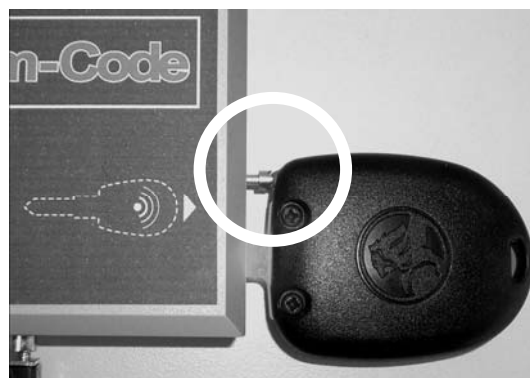

**YES!**

Fig. 9

The reading operation begins. For a few seconds the display shows:

	R	E	A	D	I	N	G		I	N		P	R	O	G	R	E	S	S

If there are problems when reading (no key, key not positioned properly, reading error, etc.) a warning message appears (see Ch. 8 "WARNINGS").

If the electronic code is read successfully, the display shows:

	R	E	M	O	V	E		K	E	Y								
I	D=	X	X	X	X	X	X											

---

**N.B: XXXXXX is the electronic code read from the original key**

---



Now remove the original key from the module.

Press **ENTER**, the display shows:

	I	N	S	E	R	T		B	L	A	N	K		K	E	Y			
																	>	W	R



After fitting the key blank into the module and pressing **WR**, for a few seconds the display shows:

	W	R	I	T	I	N	G		I	N		P	R	O	G	R	E	S	S

If writing is successful, the display shows:

	O	P	E	R	A	T	I	O	N		C	O	M	P	L	E	T	E	D



If there are problems when writing (no key, key not positioned properly, reading error, etc.) a warning message appears (see Ch. 8 "WARNINGS").

Press **ESC** to go back to the initial menu.

>	C	O	P	Y															
	E	N	T	E	R	I	N	G		C	O	D	E						

## 7.10.2 Entering the code

When "ENTER CODE" is selected on the display, the message appears:

	H	O	L	D	E	N		C	O	M	M	O	D	O	R	E			
I	D	=	_	_	_	_	_	_											

Enter the code, which comprises numbers from 0 to 9.

**ATTENTION:** The entire field of 6 numbers must be filled, if necessary adding some noughts at the beginning of the code, for example, if the code is 1368 enter 001368.

This security code must be the one for the vehicle on which the key will be used and must be known. If not, the key will not be enabled by the vehicle control unit to start the engine.

Press **ENTER**, the display shows:

	I	N	S	E	R	T		B	L	A	N	K		K	E	Y			
																	>	W	R



After fitting the key blank into the module and pressing **WR**, for a few seconds the display shows the message:

	O	P	E	R	A	T	I	O	N		C	O	M	P	L	E	T	E	D

If there are problems when writing (no key, key not positioned properly, reading error, etc.) a warning message will appear (see Ch. 8 "WARNINGS").

## 7.11 Options

This function is activated by selecting "OPTIONS". The display shows the first two items in the menu. The possible choices are shown below:

>	L	A	N	G	U	A	G	E											
	C	A	N	C	.	C	U	S	T.		A	R	C	H	I	V	E		
	K	E	Y	B	O	A	R	D		C	H	E	C	K					
	M	O	D	U	L	E													
	R	E	G	E	N	E	R	A	T	E		K	E	Y		4	2		



Select the item required and press **ENTER**.

### 7.11.1 Language

Select "LANGUAGE" to gain access to a menu from which to change the language in use.

Select the item required and press **ENTER**.

The choice is confirmed by the selected language appearing on the display. Example:

>	E	N	G	L	I	S	H												

– Press **ESC** to go back to the beginning.

### 7.11.2 Deleting the archive

This option is used to delete the read key archive memory.

The display shows:

C	O	N	F	I	R	M		C	A	N	C	E	L	L	A	T	I	O	N
					N	O	>	E	S	C		Y	E	S	>	E	N	T	



Press **ENTER** to confirm deletion of the code archive.

When the operation has been carried out, the display shows:

	C	A	N	C	E	L	L	A	T	I	O	N							
	C	A	R	R	I	E	D		O	U	T								



– Press **ESC** to go back to the beginning.

### 7.11.3 Keyboard check

This option is used to check operation of the keys.  
The display shows:

	P	R	E	S	S		K	E	Y										

When a key is pressed the right-hand side of the display shows the corresponding number/letter.

Key	Display
0 - 9	0 - 9
A B C D E F	A B C D E F
Right-hand arrow	>
Left-hand arrow	<
SHIFT	SH
RD	RD
WR	WR
ENTER	EN

- Press **ESC** to go back to the beginning.

### 7.11.4 OPTIONS MENU: SNOOP

Select SNOOP from the OPTIONS menu to check:

- SNOOP operating status
- battery status
- the SNOOP ID number
- SNOOP serial number
- SNOOP reset

### 7.11.5 OPTIONS MENU: C-BOX-MB

Select C-BOX from the OPTIONS menu to check:

- C-BOX operating status
- C-BOX software version (SW)
- C-BOX firmware version (FW)
- C-BOX ID number (IN)

Read the text on the machine display for further details.

## 7.12 Module

This option is used to check operation of the module connected to the machine, if applicable.  
After selecting the option, press **ENTER**.

If the module is not connected to the machine, is faulty or not powered properly even when connected (see Ch. 6) the display shows:

	M	O	D	U	L	E		N	O	T		D	E	T	E	C	T	E	D



- Press **ESC** to continue.

If the module is connected to the machine properly, the module ID and its software version will appear on the display.

	H	O	L	D	E	N		C	O	M	M	O	D	O	R	E			
	V	.		X	.	X													



- Press **ESC** to continue.

## 8 WARNINGS

When the machine is turned on, the state of the battery is checked.

During normal operation, when carrying out the different procedures/functions from the main menu (copying, detecting, entering codes, filing) the machine can detect any problems or faults which may occur when reading, checking or writing the transponder in the key.

The following paragraphs illustrate all the possible situations which can stop the machine, and the warning messages which appear for the operator's information.

### 8.1 Messages during key reading

If there are problems during reading of the transponder, a warning message appears.

#### TYPES OF MESSAGES WHICH MAY APPEAR AT THE END OF THE READING STAGE

1	T	R	A	N	S	P	O	N	D	E	R						
	N	O	T		D	E	T	E	C	T	E	D					

2		R	E	A	D	I	N	G		E	R	R	O	R			

3	R	E	A	D	I	N	G		E	R	R	O	R				
	T	R	A	N	S	P	O	N	D	E	R						

4	C	R	Y	P	T	O		T	R	A	N	S	P	O	N	D	E	R	
		C	A	N	N	O	T		D	U	P	L	I	C	A	T	E	X	X

5	C	R	Y	P	T	O		T	R	A	N	S	P	O	N	D	E	R	
		C	A	N	N	O	T		D	U	P	L	I	C	A	T	E	4	4

6		T	R	A	N	S	P	O	N	D	E	R							
		C	A	N	N	O	T		D	U	P	L	I	C	A	T	E	8	D

7	O	P	E	L		T	R	A	N	S	P	.		C	R	Y	P	T	O
		C	A	N	N	O	T		D	U	P	L	I	C	A	T	E	4	0

8	N	I	S	S	A	N		T	R	A	N	S	.		C	R	Y	P	T	O
		C	A	N	N	O	T		D	U	P	L	I	C	A	T	E	4	1	

9	V	A	G		T	R	A	N	S	P	.		C	R	Y	P	T	O	
		C	A	N	N	O	T		D	U	P	L	I	C	A	T	E	4	W

10	C	R	Y	P	T	O		T	R	A	N	S	P	O	N	D	E	R	
		C	A	N	N	O	T		D	U	P	L	I	C	A	T	E	4	F

11	T	R	A	N	S	.		C	R		M	I	T	S	/	V	O	L	V	O
		B	L	A	N	K													4	M

12	T	R	A	N	S	.		C	R		M	I	T	S	/	V	O	L	V	O
		C	A	N	N	O	T		D	U	P	L	I	C	A	T	E	4	M	

13	R	E	A	D		E	R	R	O	R										
	C	H	E	C	K		K	E	Y		P	O	S	I	T	I	O	N		

14	R	E	A	D	I	N	G	E	R	R	O	R							
	R	E	G	E	N	E	R	A	T	E	K	E	Y			4	5		
15	T	E	X	A	S	T	R	A	N	S	P	.	C	R	Y	P	T	O	
	T	Y	P	E	6	F	-	*	*							>	E	N	T
16	E	X	E	C	U	T	E	C	O	P	Y	?							
						N	O	>	E	S	C	Y	E	S	>	E	N	T	

**MEANING: the key**

- 1) has no transponder or is badly positioned;
- 2-3) Contains a faulty transponder, one that cannot be read or is not operational, or the key has been removed during the reading and writing stages;
- 4) has a MEGAMOS\* (48), TEMIC\* type (8C) Crypto transponder or Crypto transponder (8E);
- 5) has a PHILIPS\* type (44) "Crypto" transponder;
- 6) has a SAAB (8D) transponder (cannot be copied);
- 7) contains a Crypto transponder, PHILIPS\* type (40) for OPEL (cannot be copied);
- 8) contains a Crypto transponder, PHILIPS\* type (41) for NISSAN (cannot be copied);
- 9) contains a Crypto transponder, PHILIPS\* type (4W) for VAG (cannot be copied);
- 10) contains a Crypto transponder, PHILIPS\* type (4F) for FIAT GRP (cannot be copied);
- 11) contains a Crypto transponder, PHILIPS\* type (4M) for MITSUBISHI-VOLVO (blank);
- 12) contains a Crypto transponder, PHILIPS\* type (4M) for MITSUBISHI-VOLVO (cannot be copied);
- 13) see case 16
- 14-15) contains a Crypto2 transponder TEXAS ( see ch. 7.3.1.7 and 7.4.4.1)

In cases 1, 13, try placing the key in different positions to be read.  
 In case 2, Use a new key with transponder and try again. If a reading error has occurred on key ID42, check operation of the key (see Ch. 7.3.1.2 and 7.3.1.2.1)  
 In cases 3, 4,13, the code cannot be read and the key cannot be copied.  
 In case 5 only the ID can be copied, and not the key itself (paragraph 7.3.1 - Key reading).  
 In cases 6, 9, 12 the key cannot be copied.  
 In case 11 the key contains a blank transponder (cannot be copied) that can be added to the immobilizer system by diagnostic device.  
 In case 14, a reading error has occurred on ID45 key; before carrying out any other operation you must use the function "Regenerate Key 45" (see ch.7.3.1.6.1).

– To return to the beginning, press the **ESC** key.

\* Megamos, Philips, Temic, Texas are registered trade marks.

## 8.2 Messages during key writing

If there are problems during checking of the transponder, a warning message appears.

### TYPES OF MESSAGES WHICH MAY APPEAR AT THE END OF THE CHECKING STAGE

1		T	R	A	N	S	P	O	N	D	E	R							
	N	O	T		D	E	T	E	C	T	E	D							
2		I	N	C	O	R	R	E	C	T								X	X
	T	R	A	N	S	P	O	N	D	E	R								
3	C	R	Y	P	T	O		T	R	A	N	S	P	O	N	D	E	R	
	C	A	N	N	O	T		W	R	I	T	E						X	X

#### MEANING: THE KEY BLANK:

- 1) has no transponder or is badly positioned;
- 2) has a transponder which is not compatible with the type of transponder needed to make a copy;
- 3) has a PHILIPS<sup>\*</sup> cannot be copied (40) (41) (42) (44) (4M) (4F) (45) (4W), MEGAMOS<sup>\*</sup> type (48), TEXAS<sup>\*</sup> type (60) (61) (62) (63) (64) (65) (66) (67) (68) (69) (6F), TEMIC<sup>\*</sup> (8C) Crypto transponder or Crypto transponder (8E);

#### Suggestions for solving the problem

In cases 1 and 2, Check that the key being used is the right one and compatible with the type of copy; if necessary, repeat the writing operation on a new key.

In cases 4 the key cannot be written and therefore cannot be copied.

- To return to the beginning, press the **ESC** key.
- 

If there are problems during writing of the transponder, a warning message appears.

### TYPES OF MESSAGES WHICH MAY APPEAR AT THE END OF THE WRITING STAGE

	W	R	I	T	I	N	G		E	R	R	O	R						



#### MEANING: THE KEY BLANK:

- has a faulty transponder, one which cannot be written properly or one which is protected during writing operations.
- To return to the beginning, press the **ESC** key.

<sup>\*</sup> Megamos, Philips, Temic, Texas are registered trade marks.

### 8.3 Special events that could occur when copying a Philips\* CR2 transponder:

During the reading and copying stage for the original key, and during the Snoop initialization and test stages, the RW4 Plus machine makes checks to ensure that the calculation circuit board (C-BOX) and Snoop work properly; in the case of anomalies the display may show:

C	B	O	X		I	N	T	E	R	N	A	L		E	R	R	O	R	
	C	O	D	E	=	x	x	x											

**Anomaly:** An error has occurred on the module, indicated by code COD=XXX

**Solution:** Turn off the RW4 Plus machine for a few seconds, turn on and repeat the interrupted operation. If the problem has not been solved contact the Silca after-sales service communicating the error code shown on the machine display.

	V	E	R	I	F	Y		S	N	O	O	P								
	P	O	S	I	T	I	O	N									>	E	N	T

**Anomaly:** SNOOP has not been found by the RW4 Plus antenna.

**Solution:** Check the position of the SNOOP antenna on the machine, press "Enter" to continue.

R	E	P	L	A	C	E		S	N	O	O	P								
B	A	T	T	E	R	Y											>	E	N	T

**Anomaly:** The battery power is too low to guarantee proper operation of SNOOP.

**Solution:** Replace the SNOOP battery (consult the SNOOP instructions sheet).

S	N	O	O	P		I	N	T	E	R	N	A	L		E	R	R	O	R
	C	O	D	E	=	x	x	x											

**Anomaly:** An error has occurred on SNOOP, indicated by code COD=XXX

**Solution:** Use the diagnostic functions from the RW4 SNOOP OPTIONS menu and if necessary reset SNOOP. If the problem persists, contact the Silca After-Sales Service and communicate the error code shown on the machine display.

S	N	O	O	P		D	A	T	A		I	N	C	O	M	P	L	.		
R	E	P	E	A	T												>	E	N	T

**Anomaly:** During STAGE 2 when SNOOP is reading data from the vehicle the data needed to make a copy has not been found.

**Solution:** Repeat STAGE 2 making sure SNOOP signals successful memorization of the data (LEDs flashing).

S	N	O	O	P		I	N	C	O	R	R	E	C	T		D	A	T	A
R	E	P	E	A	T											>	E	N	T

**Anomaly:** During STAGE 2 when SNOOP is reading data from the vehicle the data needed to make a copy has not been properly read, or in STAGE 4 the original key being used is different from that used in STAGE 2.

**Solution:** Repeat the whole copying process using the original key to be copied.

K	E	Y		N	O	T													
		C	O	M	P	A	T	I	B	L	E					>	E	N	T

**Anomaly:** In STAGE 4 the original key being used is different from that used in STAGE 1, or you are trying to copy the original key onto a key that is not an EHP.

**Solution:** Insert the original key used in STAGE 1 and continue, or insert an EHP key and continue.

L	A	S	T		W	R	I	T	I	N	G		F	O	R		E	H	P
																>	E	N	T

**Cause:** EHP keys can be re-programmed only 3 times. This message indicates that the current programming operation is the last one possible.

E	H	P		N	O	T		W	R	I	T	A	B	L	E				
R	E	P	L	A	C	E										>	E	N	T

**Anomaly:** EHP keys can be programmed only three times. This message indicates that the key is no longer programmable.

**Solution:** Insert a new EHP key.



## 9 MAINTENANCE

**ATTENTION:** for repairs or replacement of parts for maintenance, the 'CE' mark is guaranteed only if original spare parts provided by the manufacturer are used.

The machine does not need any special maintenance.

Periodically clean the key housing hole with a brush.

This operation should be carried out with the machine disconnected from the mains and turned off.

**ATTENTION:** do not use compressed air

**ATTENTION:** do not open the machine for any reason whatsoever

Before starting any type of maintenance (check-up or replacement of parts) read the following instructions:

- never carry out any maintenance operation with the machine on;
- always disconnect from the mains;
- follow the instructions in the manual;
- use original spare parts.

### 9.1 Trouble shooting

FAULT	PROBABLE CAUSE
DISPLAY - WHEN THE MACHINE IS ON THE DISPLAY IS BLANK	A ) CHECK WIRING, CONNECTIONS  B ) REPLACE: - DISPLAY (AFTER-SALES SERVICE) - CONTROL PCB (AFTER-SALES SERVICE)
KEYBOARD - IS NOT WORKING ON STAND - ALONE - DOES NOT OBEY COMMANDS	A) CHECK THE CONNECTING CABLES  - REPLACE THE KEYBOARD (AFTER-SALES SERVICE)
ANTENNA - DOES NOT READ, DOES NOT WRITE	A ) CHECK WIRING  - REPLACE ANTENNA (AFTER-SALES SERVICE)
CBOX EXPANSION BOARD CBOX INTERNAL ERROR = XX (XX WITH VALUES 1 TO 20)	A) THE MESSAGE INDICATES THAT AN ERROR HAS OCCURRED ON CBOX. TURN THE DEVICE OFF, THEN ON AND TRY THE OPERATION AGAIN.  B) REPLACE: ELECTRONIC CIRCUIT BOARD

The indications above relate to the probable causes of the faults described. They are to be considered indicative and not a comprehensive list of the likely causes of faulty operation.

In the event of any other problems of faulty operation, contact the After-Sales Service.

### 9.2 Checking the wiring

When it becomes necessary to check the internal wiring on the machine proceed as follows:

- turn off the machine;
- disconnect the supply cable;
- remove the 4 plastic feet;
- remove the 4 screws inside the housing for the feet;
- remove the bottom carefully, paying attention to the wiring.

#### Checking the wiring

Check that all the connectors are properly fitted.

## 10 WASTE DISPOSAL

EU regulations establish special arrangements for the disposal of waste\*.

### Waste deriving from the machine

The machine produces no waste during its use.

### Machine

The machine is made of re-usable materials. Re-cycling is recommended ecological practice.

### Packing

The machine is consigned in a cardboard packing box which can be re-used if undamaged. When it is to be thrown away it is classified as solid urban waste and it should be placed in the special paper collecting bins.

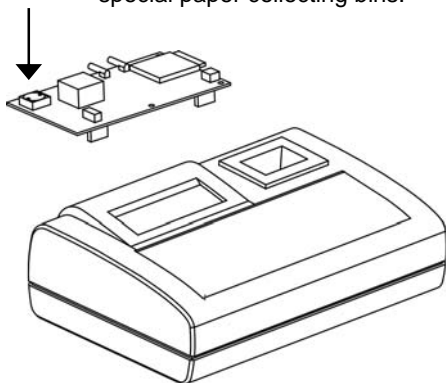

**ATTENTION: the machine contains a non-rechargeable lithium battery that must be disposed of in the special collection bins.**

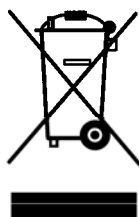

## INFORMATION FOR USERS

*as per art. 10 of Directive 2002/96/CE of 27/01/2003  
regarding waste from electric and electronic appliances (RAEE),*

- The symbol illustrated above, also found on the machine, indicates that it has been placed on the market and must be included in separate rubbish collection when the user wishes to dispose of it (including all components, sub-assemblies and consumables that are integrated in the product).
- For information about the collection system for such appliances please contact SILCA S.p.A. or another subject registered in the various National Rolls for other countries in the European Union. Household waste (or of similar origin) can be included in the separate collection system for urban waste.
- On purchasing a new appliance of equivalent type, the old one can be consigned to the dealer. The dealer will then contact whoever is responsible for collecting the appliance.
- Suitable separate collection of the unused appliance and its dispatch for treatment, recovery and environmentally compatible disposal, makes it possible to avoid potential negative effects on the environment and human health, and aids recycling and the recovery of the materials used.
- Unauthorised disposal of the product by users involves the application of the sanctions provided for in received Directives 91/156/CE and 91/689/CE.

\* "Waste" is any substance or object deriving from human activity or natural cycles, thrown way or to be thrown way.

## **11 ASSISTANCE**

Silca provides full assistance to purchasers of the machine. To ensure complete safety for the operator, any job not specified in this manual should be carried out by the manufacturer or in the special Service Centres recommended by Silca.

On the back cover of this manual there is a list of the Service Centres and relative addresses.

### **11.1 How to request service**

The guarantee attached to the machine ensures free repairs or replacements of faulty parts within 12 months of purchase. All other service calls must be arranged by the customer with Silca or with a Silca service centre.





VITTORIO VENETO 02/04/2010

## CE DECLARATION OF MACHINE COMPLIANCE

**SILCA S.p.A. - VIA PODGORA 20 ( Z.I.)  
31029 VITTORIO VENETO (TV) - (ITALY)  
TEL. 0438 9136 - FAX. 0438 913800**

Declares under its own responsibility that the **Duplicating machine For Transponder Keys**  
( 125 K Hz. ) model

### RW4 PLUS

complies with the requirements of the following European Directives:

European Union **DIRECTIVE 1999/5/CE**

and with the EN 50371 ( 2002 )  
EN 60950 – 1 ( 2006 )  
EN 301 489 – 3 V 1.4.1 ( 2002 – 08 )  
EN 301 489 – 1 V 1.8.1 ( 2008 – 04 )  
EN 300 330 – 2 V 1.3.1 ( 2006 – 04 ) Standards

General Manager Basic Production Center

**Stefano Setti**

**SILCA S.p.A.**  
Via Podgora, 20 (Z.I.)  
31029 Vittorio Veneto (TV) Italy

*A Member of the Kaba Group*

Tel. +39 0438 9136 Fax +39 0438 913800 www.silca.it info@silca.it  
P. IVA C.F. e Reg. Impr. IT03286730266 REA TV 258111  
Cap. Soc. € 10.000.000 i.v. Export TV 038851

Società soggetta a direzione e coordinamento di Kaba Holding AG, con sede in Rümlang (Svizzera),  
Hofwisenstrasse 24, ai sensi e per gli effetti degli articoli 2497 - 2497sexies del Codice Civile.



