

# UC199 - UC199 Japan

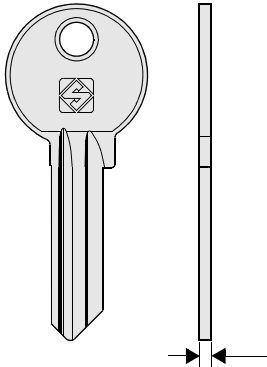

**Cutting flat keys**  
**Cifratura chiavi piatte**  
**Fräsen von Flachschlüsseln**  
**Taillage de clés plates**  
**Duplicación de llaves planas**  
**Duplicação de chaves planas**



OPTIONAL



Set Feeder

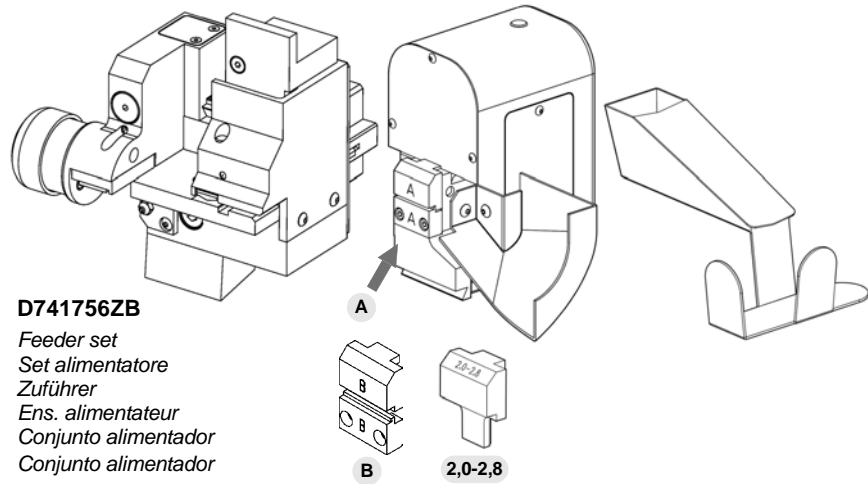

**D741756ZB**

Feeder set  
 Set alimentatore  
 Zuführer  
 Ens. alimentateur  
 Conjunto alimentador  
 Conjunto alimentador

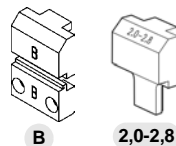

- (EN) Key thickness: min. 1,8 mm - max. 2,6 mm (with jaws A o B); min. 2,0 mm - max. 2,8 mm (with jaws A + 2,0÷2,8)  
 Max. cutting depth: 3,9 mm (with jaws A) - 2,9 mm (with jaws B)  
 Blade height/width: max. 10 mm (with jaws A); max. 9 mm (with jaws B)  
 Key head width: \*max. 28 mm

**ATTENTION: only for keys with cuts on 1 side and key stop. Not keys with plastic heads (except for Swing and Silky), not cruciform keys, not keys with tip stop.**

- (IT) Spessore chiave: min. 1,8 mm - max. 2,6 mm (con ganasce A o B); min. 2,0 mm - max. 2,8 mm (con ganasce A + 2,0÷2,8)  
 Profondità max. di cifratura: 3,9 mm (con ganasce A); 2,9 mm (con ganasce B)  
 Altezza/larghezza canna: max. 10 mm (con ganasce A); max. 9 mm (con ganasce B)  
 Larghezza testa chiave: \*max. 28 mm

**ATTENZIONE: solo per chiavi aventi 1 lato di cifratura e fermo chiave. No chiavi testa plastica (escluse Swing e Silky), no chiavi a croce, no chiavi con fermo punta.**

- (DE) Schlüssel Stärke: min. 1,8 mm - max. 2,6 mm (mit Backen A o B); min. 2,0 mm - max. 2,8 mm (mit Backen A + 2,0÷2,8)  
 Max. Tiefe der Fräsungen: 3,9 mm (mit Backen A) - 2,9 mm (mit Backen B)  
 Höhe/Breite Schaft: max. 10 mm (mit Backen A); max. 9 mm (mit Backen B)  
 Schlüsselkopf Breite: \*max. 28 mm

**ACHTUNG: nur für Schlüssel mit 1 gefrästen Seite und Schlüsselanschlag. Keine Schlüssel mit Plastikkopf (mit Ausnahme von Swing und Silky), keine Kreuzschlüssel, keine Schlüssel mit Anschlag an der Spitze.**

- (FR) Épaisseur clé: min. 1,8mm - max. 2,6mm (avec mâchoires A ou B); min. 2,0 mm - max. 2,8 mm (avec mâchoires A + 2,0÷2,8)  
 Profondeur max. de taillage: 3,9 mm (avec mâchoires A); 2,9 mm (avec mâchoires B)  
 Hauteur/largeur canon: max. 10 mm (avec mâchoires A); max. 9 mm (avec mâchoires B)  
 Largeur tête clé: \*max. 28 mm

**ATTENTION: pour les clés ayant un seul côté de taillage et un arrêt clé uniquement. Pas de clés à tête en plastique (sauf Swing et Silky), pas de clés croix, pas de clés avec arrêt sur la pointe.**

- (ES) Espesor llave: min. 1,8 mm - max. 2,6 mm (con quijadas A o B); min. 2,0 mm - max. 2,8 mm (con quijadas A + 2,0÷2,8)  
 Profundidad máx. de cifrado: 3,9 mm (mit quijadas A); 2,9 mm (mit quijadas B)  
 Altura/ancho caña: max. 10 mm (mit quijadas A); max. 9 mm (mit quijadas B).  
 Ancho cabeza llave: \*max. 28 mm

**ATENCIOM: sólo para llaves que tengan 1 lado de cifrado y tope llave. No llaves con cabeza plástico (Swing y Silky excluidas), no llaves de cruz o con tope en punta.**

- (PT) Espessura da chave: mín. 1,8 mm - máx. 2,6 mm (com garras A ou B); mín. 2,0 mm - máx. 2,8 mm (com garras A + 2,0÷2,8)  
 Profundidade máx. de corte: 3,9 mm (com garras A); 2,9 mm (com garras B)  
 Altura/largura da cana: máx. 10 mm (com garras A); máx. 9 mm (com garras B)  
 Largura cabeça da chave: \*max. 28 mm

**ATENÇÃO: só para chaves com 1 lado de corte e encosto da chave. Não para chaves com cabeça de plástico (excepto Swing e Silky), não para chaves tetra, não para chaves com encosto na ponta.**

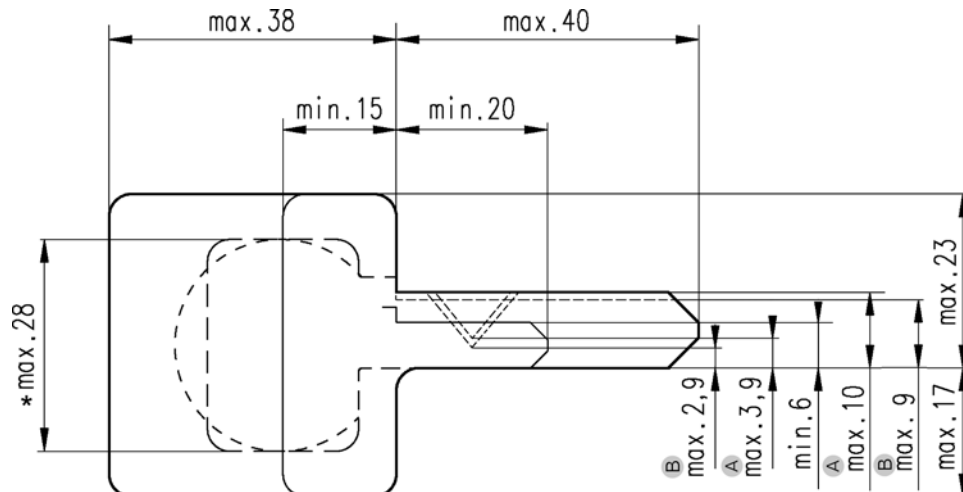

# UC199 - UC199 Japan



PER:  
FOR:

## ASSA (S)

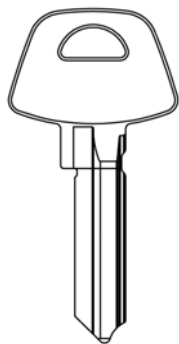

D-12

OPTIONAL



2 pcs. required

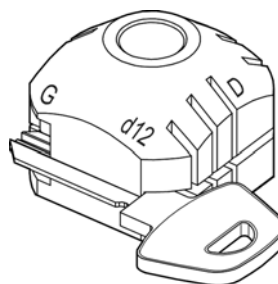

### D742393ZB









Clamp for D-12 type keys  
Morsetto per chiavi tipo D-12  
Spannbacke für D-12 Schlüsseltyp  
Etau pour clés type D-12  
Mordaza para llaves tipo D-12  
Mordente para chaves tipo D-12

**ATTENTION:** side G must not be used with the Automatic Feeder.

PER:  
FOR:

## CITROËN (F)



 SX9GP  
  SX9AP  
  SX9CP  
  SX9MH  
  SX9T6  
 SX10BP  
  SX9T14  
 SX11BP

OPTIONAL

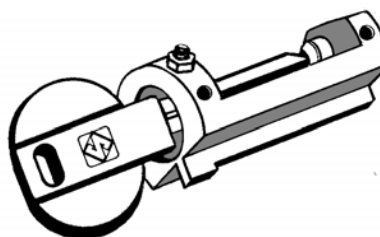

### D708040ZB

Code attachment  
Dispositivo a codice  
Code-Vorrichtung  
Dispositif à code  
Dispositivo a código  
Dispositivo por código

VALEO - SIMPLEX (F)



# UC199 - UC199 Japan



PER:  
FOR:

## ESETY (I)

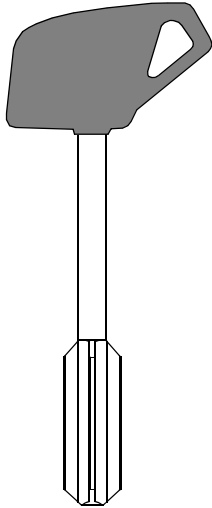

Omega

### OPTIONAL



card nr. 1532  
card nr. 2211

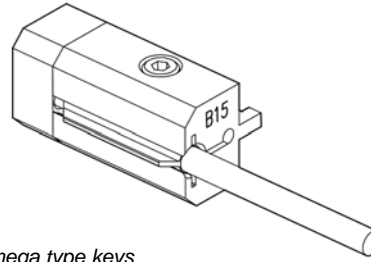

### D742353ZB

Adapter B15 for Omega type keys  
Adattatore B15 per chiavi tipo Omega  
Adapter B15 für Omega Schlüsseltyp  
Adaptateur B15 pour clés type Omega  
Adaptador B15 para llaves de tipo Omega  
Adaptador B15 para chaves tipo Omega

*System protected by a password issued by Silca on receipt of authorization.  
Sistema protetto da password rilasciata da Silca a fronte di autorizzazione.  
System geschützt durch von Silca geliefertes Password auf Genehmigung.  
Système protégé par un password qui est émis par Silca sur autorisation.  
Sistema protegido por password que expide Silca contra autorización.  
Sistema protegido por uma password emitida por Silca contra a autorização.*

PER:  
FOR:

## FORD (EU+USA)

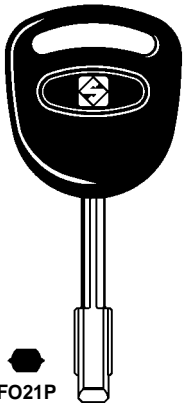

FO21P



FO21MH

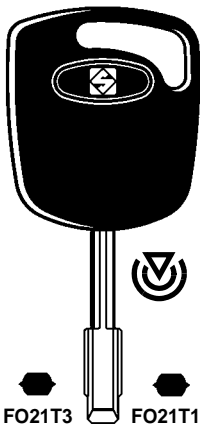

FO21T3



FO21T17



FO21AP

FO21T7

FO21T3M

### IMPORTANT!

KEY BLANK TO BE APPLIED TO THE ORIGINAL REMOTE CONTROL  
(THE REMOTE CONTROL INCLUDES THE TRANSPONDER CHIP)

TIBBE (D) - VALEO (F)

### OPTIONAL

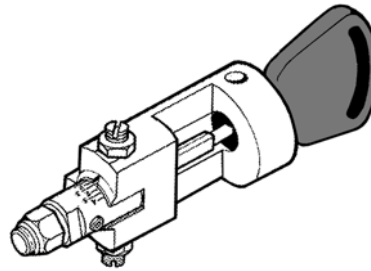

### D708704ZB

Code attachment  
Dispositivo a codice  
Code-Vorrichtung  
Dispositif à code  
Dispositivo a código  
Dispositivo por código

### D705040ZB

Cutter 06 (HSS)  
Fresa 06 (HSS)  
Fräser 06 (HSS)  
Fraise 06 (HSS)  
Fresa 06 (HSS)  
Fresa 06 (HSS)



### D706128ZB

Cutter 06W (carbide)  
Fresa 06W (metal duro)  
Fräser 06W (Hartmetall)  
Fraise 06W (au carbure)  
Fresa 06W (metal duro)  
Fresa 06W (metal duro)



# UC199 - UC199 Japan



PER:  
FOR:

## SOFER (P)

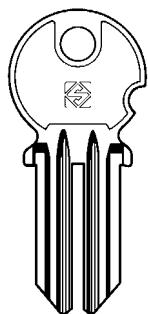

SOF1



SOF1R

### OPTIONAL



#### D742980ZB

Clamp for Sofer keys - Cutter side  
 Morsetto per chiavi Sofer - lato Fresa  
 Spannbacke für Sofer Schlüssel - Fräuserseite  
 Etau pour clés Sofer - côté Fraise  
 Mordaza para llaves Sofer - lado Fresa  
 Mordente para chaves Sofer - lado Fresa

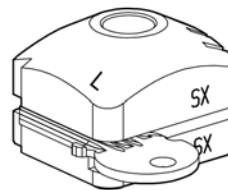

#### D742830ZB

Clamp for Sofer keys - Reader side  
 Morsetto per chiavi Sofer - lato Lettore  
 Spannbacke für Sofer Schlüssel - Leserseite  
 Etau pour clés Sofer - côté Lecteur  
 Mordaza para llaves Sofer - lado Lectora  
 Mordente para chaves Sofer - lado Lector

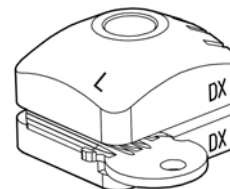

**ATTENTION:** side L must not be used with the Automatic Feeder.  
**ATTENZIONE:** il lato L non deve essere utilizzato con il gruppo Alimentatore.  
**ACHTUNG:** Seite L nicht mit Zuführeinheit verwendet werden.  
**ATTENTION:** le côté L pas être utilisé avec le groupe d'Alimentation.  
**ATENCIÓN:** el lado L no debe ser utilizado con el grupo Alimentador.  
**ATENÇÃO:** O lado L não deve ser utilizado com o conjunto Alimentador.

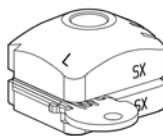
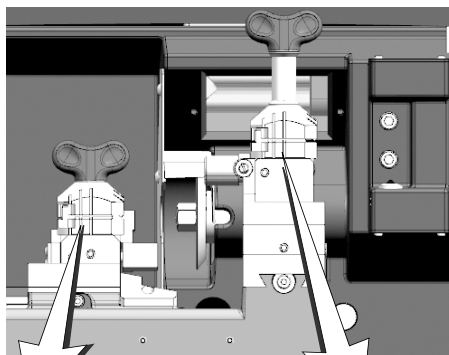

D742980ZB

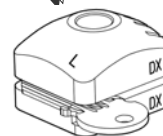

D742830ZB

